

NORTH CAROLINA

**UNIFORM REAL PROPERTY ELECTRONIC
RECORDING ACT**

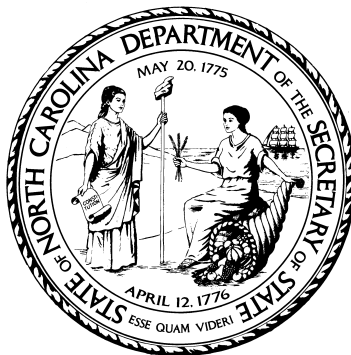

**REPORT FROM THE NORTH CAROLINA
ELECTRONIC RECORDING COUNCIL**

Pursuant to G.S. 47-16.5(b) and G.S. 47-16.5(g)(1)

September 12, 2006
Revised September 5, 2007
Revised February 18, 2009
Revised effective March 7, 2011
Revised effective October 20, 2011

Table of Contents

PART ONE	4
INTRODUCTION	4
PART TWO	6
NORTH CAROLINA ELECTRONIC RECORDING STANDARDS	6
1. Data and Document Formatting.....	6
2. Electronic Payment of Recording Fees.....	6
3. Security	7
4. Trusted Submitter Registration	7
5. Submission for Recording.....	7
6. Document Return	7
7. E-Document Processing Methods and Systems.....	8
8. Security Backup and Disaster Recovery.....	8
9. Notary Acknowledgement/ Signature.....	8
10. Long Term Retention and Preservation of Digital Records.....	8
11. eRecording of Maps and Plats	9
PART THREE	10
NORTH CAROLINA ELECTRONIC RECORDING STANDARDS	10
WITH COMMENTS	10
PART FOUR.....	22
CONCLUSION and CONCERNS.....	22
PART FIVE	23
APPENDIX.....	23
ADDENDUM A	24
Glossary of Terms.....	24
ADDENDUM B.....	29
FREQUENTLY ASKED QUESTIONS (FAQ)	29
ADDENDUM C.....	36
eRecording Models Explained.....	36
ADDENDUM D	41
Survey Results and Comments	41
ADDENDUM E.....	57
Archival Process For Data And Image Preservation	57
ADDENDUM F	67
Security Backup Files	67
ADDENDUM G	70
Acronyms Used In This Document.....	70
ADDENDUM H	72
SESSION LAW 2005-391	72
ADDENDUM I.....	77
G. S. §47-14 As Amended By	77
Session Law 2008-194.....	77
ADDENDUM J.....	80
Statutes Affected by e-recording or e-notary.....	80
ADDENDUM K	90

EXAMPLES: VENDOR MEMORANDUM OF UNDERSTANDING AND SUBMITTER AGREEMENT.....	90
ADDENDUM L.....	103
EXAMPLE OF A SERVICE LEVEL AGREEMENT.....	103
ADDENDUM M.....	107
N.C. Advisory Council E-notary Report.....	107
ADDENDUM N.....	113
North Carolina’s Real Estate Recording Laws: The Ghost of 1885.....	113
ADDENDUM O.....	143
The eRecording of Maps and Plats: History and Background of the Legal and Professional Opinions with References to Enabling Legislation.....	143

PART ONE

INTRODUCTION

The status of electronic information technology has progressed rapidly in recent years. Innovations in software, hardware, communications technology and security protocols have made it technically feasible to create, sign, and transmit electronic transactions.

However, various state and federal laws limited the enforceability of electronic transactions. In response, the Uniform Electronic Transactions Act (UETA) was approved by the National Conference of Commissioners on Uniform State Laws (NCCUSL) in 1999. As of October 1, 2004, UETA had been adopted in 46 states, the District of Columbia, and the U.S. Virgin Islands. The federal Electronic Signatures in Global and National Commerce Act (E-Sign) was also adopted in 2000. These two acts give legal effect to transactions that are executed and transmitted electronically and allow them to be enforced between the parties to the transaction. North Carolina also adopted similar legislation.¹

Documents resulting from electronic transactions are, therefore, valid and enforceable between parties. However, there are differing opinions as to whether those electronic documents may be recorded in the various local land records offices in states that have adopted UETA. Legacy laws and regulations in many states limit recordable documents to ones that are in writing, on paper, or require that they be originals. Other laws and regulations require signatures to be in writing and acknowledgements to be signed. Documents that are delivered electronically, regardless of the mode of creation, may not be recordable under the laws of those states.

Despite differing opinions, recorders in numerous jurisdictions have begun recording electronic documents. These efforts depend on the initiatives of individual recorders and the opportunities available under the laws of those states. They offer limited interoperability among the recording venues and across state lines. They do not provide a uniform legal structure for the acceptance and processing of electronic documents.

The Uniform Real Property Electronic Recording Act (URPERA) adopted by NCCUSL in 2004, and enacted in North Carolina in 2005, removed any doubt about the authority of the recorder to receive and record documents and information in electronic form, at the recorder's option.

Before statewide implementation can occur, the interests of many stakeholders must be considered. Under the mandate of URPERA, the North Carolina Electronic Recording Council has gathered information from those likely to experience the impact of electronic recording. See Addendum D for the full report and survey results.

¹ Chapter 66, NCGS

In analyzing each practice and method used for electronic recording, the North Carolina Electronic Recording Council (NCERC) has identified the most logical areas of concern pursuant to the statutory requirements set forth in URPERA. Nine areas were selected for research. Tasks were divided among the council members for research and interviews commenced. This report is the result of those efforts.

The following material is divided into four separate components. Part Two presents the North Carolina Electronic Recording Standards as defined by the council. The boxed copy following each standard provides NCERC commentary on the proposed standard. Part Three restates each standard and gives an explanation for the standard as proposed by the council as well as potential processes for actual implementation. Part Four explains common concerns of the council. Part Five provides supporting documentation and committee reports and should be used as an educational resource for those trying to understand the concept of electronic recordation.

PART TWO

NORTH CAROLINA ELECTRONIC RECORDING STANDARDS

1. Data and Document Formatting

Electronic recording shall be permitted only when authorized by a register and only when the submission complies with the register's data and document formatting requirements for electronic recording and with State and local procedural and formatting laws. This encompasses all documents that are currently recorded in Registers of Deeds offices.

Property Records Industry's Association (PRIA) data and document standards are the current preferred standard for use by industry participants of electronic document recording. The NCERC recommends that the recorders in North Carolina, in consultation with private and public sector recording peers, adopt the PRIA Standards on document formatting and document data fields. Electronic recording vendors need to provide a method to verify the size of each instrument presented to the Register of Deeds electronically.

It is further recommended that in order to foster and retain commerce and revenue in the state of North Carolina that electronic recording be offered and conducted with all three models of submission. (Please see Addendum C for a full explanation of models.)

2. Electronic Payment of Recording Fees

Electronic payment of recording fees shall be collected by public agencies as prescribed by state and local standards and in accordance with accepted industry standards without incurring unreasonable electronic processing fees.

The NCERC recommends that counties explore payment methods suitable for the collection of recording fees that will facilitate electronic recording and commerce in North Carolina and will not place a financial burden on the Register of Deeds or the county.

3. Security

Participants of electronic recording shall develop security standards and policies based on industry accepted security practices and protocols.

The NCERC recommends that regardless of the chosen method of security, all electronic documents be secured in such a way that both the transmitting and receiving parties are assured of each other's identity, and that no unauthorized party can view or alter the electronic document during transmission, processing, and delivery.

4. Trusted Submitter Registration

Document submitters shall be recognized and authenticated as trusted submitters in accordance to G. S. §47-14(a1).

The NCERC recommends that recorders require a form of electronic verification, whether username/password, digital signature, or similar process that provides a level of reliability and security for both parties. The goal of Trusted Submitter Registration is to establish a level of verifiable integrity within the electronic recording process.

5. Submission for Recording

Documents submitted electronically for recording shall utilize authentication and transmission methods that ensure the integrity of the submitted documents, and endorsed by submitter in accordance to G. S. §47-14(a1).

The NCERC recommends that the Recorder and Submitter agree to login parameters and transmission protocols as may be defined in the Memorandum of Understanding and the requirements of G.S. § 47-14 (a1).

6. Document Return

Appropriate notification of a document recording or rejection of an electronic document may be provided to electronic document submitters by recorders.

The NCERC recommends that each county recorder shall decide how information on document recording or rejection will be communicated to submitters.

7. E-Document Processing Methods and Systems

Registers shall maintain system and processing neutrality.

The NCERC recommends that recorders maintain a technology-neutral system to receive, store, and archive electronic documents.

8. Security Backup and Disaster Recovery

Registers shall have a security backup policy in place, and procedures or a Service Level Agreement for disaster recovery.

Given the importance and sometimes fragile nature of data, the NCERC recommends that a security backup policy, system restoration procedures, and a Service Level Agreement for electronic data and information be established and documented.

9. Notary Acknowledgement/ Signature

The rules and regulations should facilitate and accommodate all models of electronic submission.

10. Long Term Retention and Preservation of Digital Records.

The permanent or long-term preservation of digital records should comply with the following standards:

- **Maintain multiple copies of the record.**

- **Maintain the original, unchanged, recorded file in the original file format throughout the life of the record.**
- **Perform periodic audits on the records and the system to ensure long-term accessibility to the records.**
- **On a continuing basis, develop planning and implementation procedures for conversion and migration (the preservation of access over time) of permanent or archival digital records, and the systems that support them, to new formats, storage media, and technologies.**
- **Assure that digital information can be managed, authenticated by currently acceptable technologies and accessed over time by creating and maintaining metadata.**
- **When digital technology is used for recording permanent, archival or legal records, the original record should be transferred to microfilm for permanent preservation.**

The NCERC also recommends the additional policies and procedures outlined in Addendum E, “Archival Process of Data and Image Preservation”, as well as the statutes that govern these measures, be followed to assure protection and access of digital information.

11. eRecordation of Maps and Plats

The electronic recordation of any map or plat shall be permitted pursuant to these standards only if performed in accordance with the North Carolina General Statutes and county rules regarding the presentment of maps.

The NCERC recommends that the legal and professional opinions contained in Addendum O of these standards which include 1) the N.C. Attorney General’s Opinion dated 4-13-2010; 2) the 7/28/2009 legal opinion from Professor Pat Hetrick, Land Records Advisory Council Chair; and 3) the N. C. Society of Surveyors professional opinion dated 5-7-2010 be consulted in addition to other prevailing statutes for the legal basis for the submission and recordation of electronic maps. Further, the NCERC recommends that electronically-recorded maps and plats be visually compatible with documents presented on paper or mylar and that the certified original resolution be preserved.

PART THREE

NORTH CAROLINA ELECTRONIC RECORDING STANDARDS WITH COMMENTS

1. Data and Document Formatting

Electronic recording shall be permitted only when authorized by a register and only when the submission complies with the register's data and document formatting requirements for electronic recording and with State and local procedural and formatting laws. This encompasses all documents that are currently recorded in Registers of Deeds offices.

Comments

Document technologies include those that create the document and its format, such as word processing applications, text editors, proprietary document assembly software, etc. Regardless of the application used to create the document, the format of the document is critical to the county recorder and others, who must be able to view, save, print, store and rely on the validity of the document.

Formats being used today include TIFF, PDF, HTML and XHTML, all of which can be viewed, stored, and printed using commonly-available, freely-distributed viewer technology such as web browsers, document reading software, or operating system tools. Document format also encompasses paper size and font size. Currently, only letter and legal size paper documents are accepted. In an electronic environment, standard letter size (8 ½" x 11") and font size of no smaller than 10 points, facilitate easier processing in matters such as page count and determining proper recording fee amounts. (See Standard 11 for the requirements for the eRecordation of maps and plats.)

With regard to data format, documents need to be associated with useable data to improve the recording process. The capability to format the data contained in the document, or carried with the document, is important. XML is a widely used and often preferred method for providing access to the data contained in the document. Along with industry standard definitions for the data, XML can provide both a standardized common dictionary and a common data structure for use by county recorders and document submitters.

When considering XML, it is important to remember that county recorders do not prepare the documents submitted to them for recording, but rather record and index documents submitted by others. Therefore, it is essential they adopt compatible standards in order to reuse what already exists. The Property Records Industry Association (PRIA) has XML standards for county recorders. From the interviews conducted, the council learned that many jurisdictions as well as

private sector participants, have adopted PRIA standards. (See Survey Results for PRIA Based Standards Table) Mecklenburg County, North Carolina also adopted PRIA standards for implementation of electronic recording.

Survey Results for PRIA Based Standards

County or Private Sector	Using PRIA Based Standards?
Broward County, FL	Yes
Davidson County, TN	Yes
District of Columbia	Yes
Douglas County, CO	Yes
Fairfax County, VA	Yes
Lancaster County, PA	Yes
Maricopa County, AZ	Yes
US Recordings, MN	Yes
Snohomish County, WA	Yes
Monmouth County, NJ	No

PRIA has also developed a widely recognized data and document type hierarchy that can be used to provide electronic documents in a uniform and consistent fashion. At a high level, this hierarchy takes the shape of three distinct document models. These are explained in the PRIA I-guide in sections 2.3.1, 2.3.2, and 2.3.3 along with a table that clarifies the differences among these models, and two additional tables that outline the benefits and issues surrounding these models. A copy of this information can be found in Addendum C of this document.

The topic of multiple models and the reality of various types of submitters prompted this council to conduct different polls and surveys among local private and public entities. Of special concern was the imposition and requirement of using a digital certificate when signing Model 3 documents.

The Council discovered that the public and private sectors interviewed based their interest in participating in an electronic recording program on their capabilities and the specific requirements associated with each model. For example, there were responses that indicated selected users would avoid submitting at Model 3 only due to the digital certificate requirement. Others stated that based on their document volumes and capabilities, they would only be able to participate at models 1 and 2. It appears that in order to better encourage registers and recruit submitters to use electronic recording all three models must be made available. To review the results and comments from the private sector on these surveys please see Addendum D.

Property Records Industry Association (PRIA) data and document standards are the current preferred standard for use by industry participants of electronic document recording. The NCERC recommends that the recorders in North Carolina, in consultation with private and public sector recording peers, adopt the PRIA Standards on document formatting and document data fields. Electronic recording vendors need to provide a method to verify the size of each instrument presented to the Register of Deeds electronically.

It is further recommended that in order to foster and retain commerce and revenue in the state of North Carolina, electronic recording be offered and conducted at all three models of submission. (Please see Addendum C for a full explanation of models.)

2. Payment of Recording Fees

Electronic payment of recording fees shall be collected by public agencies as prescribed by state and local standards and in accordance with accepted industry standards without incurring unreasonable electronic processing fees.

Comments

Payments are a prerequisite to all methods of recording. PRIA research shows that payment problems are a primary reason for document rejection in the paper world.² The ability to handle various types of payments should reduce rejections in the electronic world.

Whether or not a payment is attached or an authorization of payment is included in a recording submission, the submission must incorporate some methodology for payment of fees associated with a particular document or set of documents.

Typical payment options include: ACH (Automated Clearing House), internal escrow accounts, credit and debit cards, and journal vouchers. The majority of jurisdictions interviewed currently engaged in electronic recording collect payment through ACH or by internal escrow accounts (See graphs on next page.)

² PRIA “URPERA Enactment and eRecording Standards Implementation Guide”

Non-North Carolina Jurisdictions Payment Preference

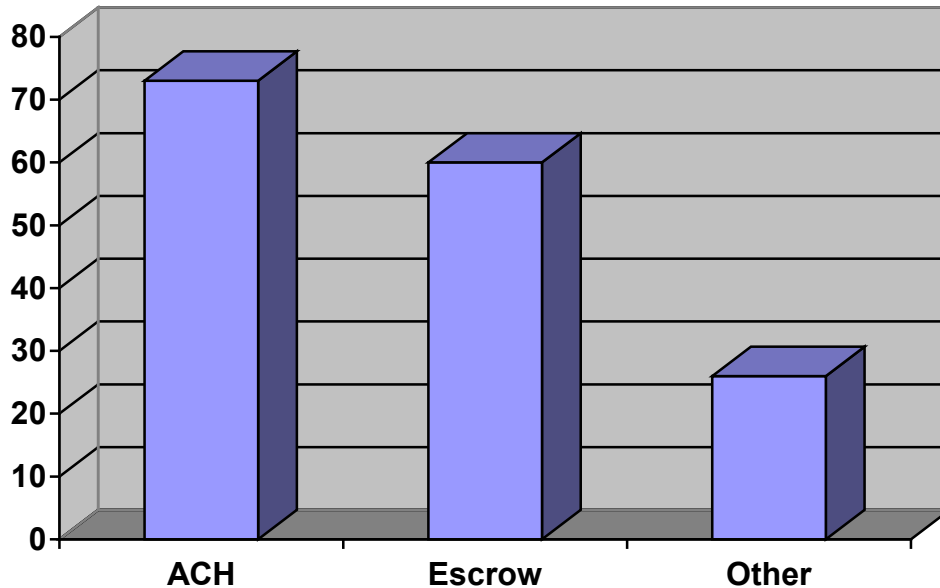

Of the North Carolina jurisdictions interviewed, ACH payment processing was the preferred payment method, over escrow accounts or credit card payments. Please see Addendum D for further details.

This council discovered that ACH was currently being used in the recorder's offices of Broward County, Florida, Maricopa County, Arizona, Douglas County, Colorado, Lancaster County, Pennsylvania and Fairfax County, Virginia, as well as in the private sector at places such as US Recordings, Land America Title and Land America Financial, both in Maricopa County, Arizona, and Land America Financial Group, Greenwood Colorado. There may be a small transaction cost associated with ACH payments that should be addressed when considering adoption of this payment method.

Escrow accounts for recording fees have been in use for some time for paper documents. This payment method is readily transferable to electronic transactions and offers the benefit that payment integration may already be in place. Payments are debited from the submitter's account and credited to the recorder's account. The submitter is notified of the debit amount to reconcile its accounting, and replenishes the debited amount to maintain the agreed upon account balance. Generally, if the account balance falls below an agreed upon amount, documents will not be recorded.

A benefit to escrow accounts is the ability to record a document even if the correct recording fee is not included. Another benefit is that overpayments can be credited to the account, saving a

recorder time and expense in requisitioning a refund check. Internal escrow accounts are used in Douglas, Monmouth, Snohomish and Maricopa Counties, and at US Recordings.

Fees are to be collected according to statute, in a manner consistent with the promotion of electronic recording, and in accordance with accepted industry standards. Each county recorder may collect electronic recording fees in a manner compatible with its internal software and county financial practices.

The NCERC recommends that counties explore payment methods suitable for the collection of recording fees that will facilitate electronic recording and commerce in North Carolina and will not place a financial burden on the Register of Deeds or the county.

3. Security

Participants of electronic recording shall develop security standards and policies based on industry accepted security practices and protocols.

Comments

As government and business entities migrate to electronic processes, they should base those processes on accepted security practices and protocols. Participants must decide how much security is enough for their respective parts of the transaction. Submitters will have established a level of security they deem appropriate for both transactional and organizational security.

Transmission and receipt of electronic documents, electronic data, and recording fees shall be at a level so as to prevent data interception, tampering or altering of data, or theft of electronic data. Requirements and guidance should factor in federal, state, and local laws and regulations.

Encryption accommodates a more secure transmission of information. Hashing is an additional layer of security that ensures that the information has not changed during the transmission. Hashing allows Registers of Deeds to determine whether what they receive is exactly what was sent. However, hashing capabilities may not be available with Model 1 recording.

Parties may agree to transactional security procedures such as use of link control, e.g., virtual private networks (VPN) and Secure Socket Layer (SSL), data encryption, access control, and identification and authentication of individuals, companies, servers and software.

The NCERC recommends that, regardless of the chosen method of security, all electronic documents be secured in such a way that both the transmitting and receiving parties are assured of each other's identity, and that no unauthorized party can view or alter the electronic document during transmission, processing, and delivery.

4. Trusted Submitter Registration

Document submitters shall be recognized and authenticated as trusted submitters in accordance to G. S. §47-14(a1).

Comments

To promote confidence in the electronic recording process, recorders should identify submitters that are authorized to submit documents electronically and, therefore, thus better insure the integrity of the process.

A trusted submitter is an entity that intends to submit electronic documents for recording. Recorders may maintain a registry in written or electronic form of trusted submitters..

Recorders are encouraged to require a form of electronic verification, whether digital signature, username/password, or, similar process that provides a level of reliability. The goal of Trusted Submitter Registration is to establish a level of verifiable integrity within the electronic recording process.

Recorders shall establish a Memorandum of Understanding (MOU) with each submitter.³ This memorandum may include the rights and responsibilities of county recorders and the submitter, and serves to provide a general understanding between the parties. It may contain a listing of recording fees, hours of operation and holiday schedules. It may also include or reference certain standards that should be practiced or observed. This council found the use of an MOU in place at Mecklenburg, Maricopa, Douglas, Snohomish, Lancaster, Monmouth, Davidson and Fairfax counties, Land America Financial Group in Greenwood, Colorado, and requires its use as an integral part of eRecording.

<p>The NCERC recommends that recorders require a form of electronic verification, whether username/password or digital signature, or similar process that provides a level of reliability and security for both parties. The goal of Trusted Submitter Registration is to establish a level of verifiable integrity within the electronic recording process.</p>

5. Submission for Recording

Documents submitted electronically for recording shall utilize authentication and transmission methods that ensure the integrity of the submitted documents and endorsed by submitter in accordance to G. S. §47-14(a1).

Comments

The submitters and recorders are fortunate in that there is an infrastructure in place for document transmissions. It is the Internet. Because that infrastructure exists, including the technologies

³ Example of MOU is in Addendum K

necessary to transmit documents, the additional effort needed for eRecording is relatively minimal. The parties provide their own connections and interfaces with the Internet.

In addition, those parties make choices on a delivery method: email, web-based (HTTP) or file-based (FTP). Some of the earlier eRecording efforts used basic links between the submitters and recorders. Recently, the transmission links have become more robust and complex. New Internet protocols have been developed to enhance the functionality of e-commerce. Web services and portals are becoming increasingly popular because they enable Internet-based applications to create, send, process, store, archive, and retrieve documents and information with less effort and human intervention. Networks use directories to determine who has access, under what circumstances, and what privileges a user has on the network.

Once the documents are created, packaged, addressed, and endorsed by submitter in accordance to G. S. §47-14(a1), parties must be capable of sending or receiving them. Submitters should be able to send single documents or groups of documents to county recorders within a single electronic transmission.

These documents may be logically associated, much like in the paper based world. Multiple documents from a single real estate transaction (e.g., a deed, deed of trust, and assignment), may be bundled into an electronic package.

Neither MISMO nor PRIA sets data transmission standards. Choices are left to the individual organizations, based on their own business requirements. An advantage of adopting a statewide transmission standard like HTTP, HTTPS, or FTP for eRecording is that it provides a single method of transmission for submitters that record documents in multiple counties within that state.

Recorders need authentication policies and protocols to ensure the integrity of the transmission process. They need to be able to verify that county-specific requirements have been met, and know that the payment or payment authorization is from someone capable of authorizing it. Recorders also need to be capable of limiting access to their networks only to authorized submitters.

Hardware and software firewalls can control access based on identity, transmission protocol, and other factors. Recorders can also incorporate other features such as anti-virus and other security software. Other security techniques can protect against Internet attacks designed to gain access to recorders' computer resources.

A registered submitter should be provided login transmission protocols/documentation which allow uploading of a document(s). Web services such as provided by third party vendors and portals may also be options. If web services are used, both the web services provider and the recorder, as business partners, must agree and be satisfied on the transmission protocols used.

Portal Diagram

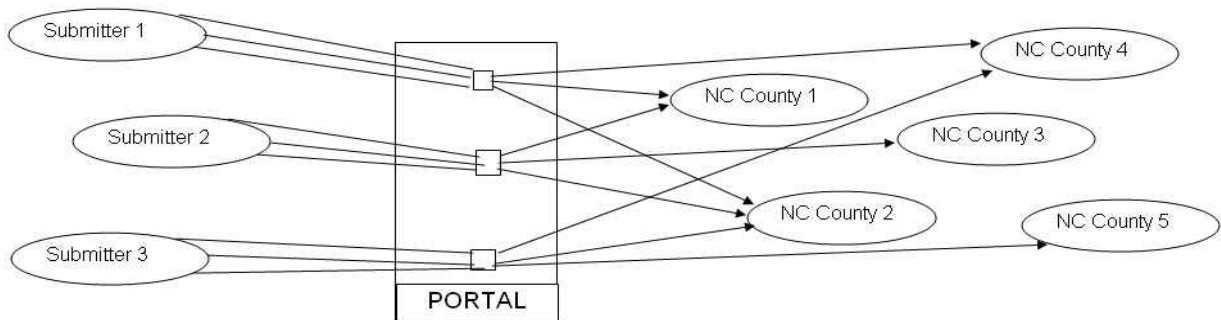

The NCERC recommends that the Recorder and Submitter agree to login parameters and transmission protocols as may be defined in the Memorandum of Understanding and the requirements of G. S. §47-(a1).

6. Document Return

Appropriate notification of a document recording or rejection of an electronic document may be provided to electronic document submitters by recorders.

Comments

Recorders, while under no statutory obligation to return a recorded electronic document, are encouraged to provide, if practical, notification and recording information that is helpful to a document submitter. This type of information is usually provided in the traditional paper recording process via return mail or other delivery. Other methods compatible with the recorders' document management processes may also be considered.

The NCERC recommends that each county recorder shall decide how information on document recording or rejection will be communicated to submitters.

7. E-Document Processing Methods and Systems

Registers shall maintain system and processing neutrality.

Comments

The NERC is mindful that technology changes rapidly, and has found the use of vendor specific processing systems to be a detriment to electronic recording. By vendor specific, it is

meant that a party desiring to electronically record documents must use a specific vendor's product in order to communicate with a recorder's internal processing system.

Much like the paper-based system, an electronic system or process used by a recorder should be capable of receiving documents using non-proprietary and standard methodology, from a variety of submitters, using a variety of technologies. Processing methods and systems may include, but are not limited to, the use of a print-to-record process, manual review, and automatic hands-off processing.

Also of equal importance is the archival process as associated with data and image preservation. Please see Addendum E for a full description of this process.

The NCERC recommends that recorders maintain a vendor neutral system to receive, store, and archive electronic documents.

8. Security Backup and Disaster Recovery

Registers shall have security backup policy and procedures in place, and a Service Level Agreement for disaster recovery.

Comments

Electronic data and information are valuable and critical assets. Security backups are vital to the survival of electronic data. Human or natural disasters, such as the terrorist attack of 9/11 or Hurricane Katrina, accidents involving the handling of media, and human error make electronic media vulnerable to damage.

When meticulously planned and properly implemented, security backups make possible the retrieval of lost data and the resumption of system operations. Such procedures are a critical part of computer operations at all levels, especially those involving the storage of long-term or permanent records on electronic media. For many applications, multiple copies and generations of backups are recommended.

Security backup files are records, but should always be associated with the records they serve to protect. Since electronic records must be indexed or otherwise made accessible for official use, security backup files do not function like records in their pure form. Security backup files are generated expressly for the purpose of restoring computer systems in the event of a disaster or accidental damage, must be manipulated before use, and should be considered a separate procedure from archiving requirements.

A Service Level Agreement (SLA) could also be used between both the vendors that would provide services and the IS/IT shops that support these systems.⁴ A clear definition and

⁴ See Addendum L for an example of an SLA

documentation of expectations for all concerned would certainly assist in assuring understanding and cooperation should a disaster occur, and protect the liability of the record managers.

A full report on Security Backup Procedures provided by the NC Department of Cultural Resources can be found in Addendum F.

Given the importance and sometimes fragile nature of data, the NCERC recommends that a security backup policy, system restoration procedures, and a Service Level Agreement for electronic data and information be established and documented.

9. Notary Acknowledgement/Signature

The rules and regulations should facilitate and accommodate all models of electronic submission.

Comments

The Secretary of State convened an Electronic Notarization Council in 2006 that developed e-Notary standards for North Carolina.⁵

10. Long Term Retention and Preservation of Digital Records.

The permanent or long-term preservation of digital records should comply with the following standards:

- **Maintain multiple copies of the record.**
- **Maintain the original, unchanged, recorded file in the original file format throughout the life of the record.**
- **Perform periodic audits on the records and the system to ensure long-term accessibility to the records.**
- **On a continuing basis, develop planning and implementation procedures for conversion and migration (the preservation of access over time) of permanent or archival digital records, and the systems that support them, to new formats, storage media, and technologies.**
- **Assure that digital information can be managed, authenticated by currently acceptable technologies and accessed over time by creating and maintaining metadata.**
- **When digital technology is used for recording permanent, archival or legal records, the original record should be transferred to microfilm for permanent preservation.**

⁵ Please see Addendum M for the eNotary Standards

The NCERC also recommends the additional policies and procedures outlined in Addendum E, “Archival Process of Data and Image Preservation”, as well as the statutes that govern these measures, be followed to assure protection and access of digital information.

Comments

Rapid changes in technology make it difficult to predict future technological alternatives. Thus, no universal solution exists today for the permanent or long-term preservation of digital records. Successful digital preservation requires a variety of different strategies. These strategies may include migration of file formats, emulation of computer hardware and software, and "normalization" of file formats from one file format to another (for example, converting a Microsoft Word© file to an XML document).

Trustworthy records can conclusively demonstrate their authenticity and integrity. Standard 10 lists components critical to assuring the integrity of digital records and preserving them in perpetuity.

Regularly scheduled migration of archival digital objects to new media, based upon a continuing assessment of developments in digital technology, should be part of a digital risk management plan. Such a plan will also include maintaining hardware and software that will migrate archival data to new media and the creation of documentation that will record information about all data formats, each type of media, required environmental conditions, processes for maintaining archival characteristics, and efforts to reduce risk. Specifically, hardware should be evaluated, and migrated and possibly upgraded at regular intervals as established by industry standards. Digital media, hardware, and files should be annually audited, tested, and sampled for corruption, deterioration, and continued accessibility. Documents should be hashed at every migration of software and hardware and the hash maintained with the document. As with every aspect of using digital technologies, all actions should be documented. Digital data will not be readable or useable, or legally acceptable, in the future without active management.

Metadata creation and management are integral to the long-term retention of electronic records. Metadata provides meaning, context, and chain-of-custody for digital information. Assuring the association of metadata with data is necessary since metadata may be stored separately or embedded in digital objects. One example of metadata is the current Indexing Standards of Land Records.

Digital technology is not currently suitable for the storage of records possessing permanent archival or legal value. The preservation of these records, especially in the event of a human-made or natural disaster, requires properly processed and stored microfilm. Microfilm is also legally acceptable as evidence according to *North Carolina General Statutes* § 8-45.1 (Photographic reproductions admissible; destruction of originals) and § 153A-436 (Photographic reproduction of county records). *North Carolina General Statutes* § 8-45.1 (b) and § 153A-436

(f) specifically prohibit the use of “computer-readable storage media...for preservation duplicates, as defined in G.S. 132-8.2, or for the preservation of permanently valuable records as provided in G.S. 121-5(d), except to the extent expressly approved by the Department of Cultural Resources....”

11. eRecordation of Maps and Plats

The electronic recordation of any map or plat shall be permitted pursuant to these standards only if performed in accordance with the North Carolina General Statutes and county rules regarding the presentment of maps.

The NCERC recommends that the legal and professional opinions contained in Addendum O of these standards which include 1) the N.C. Attorney General’s Opinion dated 4-13-2010; 2) the 7/28/2009 legal opinion from Professor Pat Hetrick, Land Records Advisory Council Chair; and 3) the N. C. Society of Surveyors professional opinion dated 5-7-2010 be consulted in addition to other prevailing statutes for the legal basis for the submission and recordation of electronic maps. Further, the NCERC recommends that electronically-recorded maps and plats be visually compatible with documents presented on paper or mylar and that the certified original resolution be preserved.

Comments

Following the eRecording of three (3) maps through a pilot project in Johnston County, NC, surveyors and county registers of deeds expressed concerns about the legality of the submission and receipt of electronically recorded maps. Specifically, do state and federal legislative acts such as the Uniform Electronic Transactions Act, the Uniform Real Property Electronic Recording Act, and eSign satisfy the requirements set forth in G.S. §47-30, “Plats and subdivisions; mapping requirements?”

Upon obtaining the Attorney General’s Opinion and other legal and professional opinions supporting the legal ability for electronic maps to be recorded, there were still some concerns, not so much about the legality of submitting and recording electronic maps/plats, but about assuaging the fears of some who were still not convinced and needed clarification in writing as to the full statutory support codified in Chapter 66, Article 40 (UETA), and G .S. §47 -16 (URPERA). The N.C. Association of Registers of Deeds is seeking legislative measures to that end.

PART FOUR

CONCLUSION and CONCERNS

The North Carolina Electronic Recording Council has demonstrated over the last year a strong commitment to carry out the instructions of the Secretary of State as outlined in NCGS 47-16.4 (See Addendum H, Sessions Law 2005-391). NCERC members believe that these standards set a sound foundation for the future of electronic transactions and also realize the important role that e-standards will play in promoting and facilitating electronic commerce in North Carolina.

Although the use of electronic recording standards recommended will assure a smooth and comprehensive implementation, the council identifies the following concerns:

- It will be important to educate and familiarize the public and private sector participants on the benefits of electronic records, assuring participants that security levels are equal to or greater than the security of paper records and that in-state and out-of-state commerce is enhanced to better meet the needs of the private and public sectors.
- North Carolina's General Statutes need to reflect both the technological and traditional needs of the real estate industry and other industries utilizing electronic commerce for both paper and electronic records, so that the recording and notarization processes do not impede the flow of commerce. (Addendum J, Statutes affected by eRecording or eNotary)
- Current registration statutes are outdated and are in conflict with recording procedures. They do not address modern modes of delivery and the volume of transactions that exist today. The addition of electronic delivery of instruments highlights the recording priority conflict. Multiple methods of delivery have complicated the priority issue during the last two hundred years, yet the problem remains. Application of the current statutes varies across the state. It is impossible to determine a method that assures all transactions are processed with the same intent, including electronic transactions. (See Addendum N, North Carolina Central University School of Law Journal Volume 28, Number 2; Spring 2006 – "North Carolina's Real Estate Recording Laws: The Ghost of 1885")
- Electronic access to state and local agencies (other than registers of deeds) associated with the recording process must be available in order to fully appreciate the value of electronic records.

The solutions for these concerns are necessary, and should facilitate the adoption of electronic procedures.

**PART FIVE
APPENDIX**

ADDENDUM A:	Glossary of Terms
ADDENDUM B:	Frequently Asked Questions (FAQ)
ADDENDUM C:	eRecording Models Explained
ADDENDUM D:	Survey Results and Comments
ADDENDUM E:	Archival Process For Data and Image Preservation
ADDENDUM F:	Security Backup Files
ADDENDUM G:	Acronyms Used In This Document
ADDENDUM H:	Session Law 2005-391 NC URPERA
ADDENDUM I:	Session Law 2008-194 G. S. §47-14
ADDENDUM J:	Statutes Affected by eRecording or eNotary
ADDENDUM K:	Example of Memorandum of Understanding
ADDENDUM L:	Example of a Service Level Agreement
ADDENDUM M:	NC Advisory Council E-notary Report
ADDENDUM N:	North Carolina Central Law Journal, Spring 2006, Volume 28, Number 2 – North Carolina’s Real Estate Recording Laws: The Ghost of 1885

ADDENDUM A

Glossary of Terms

- **Asymmetric encryption:** A method that uses two keys – a public key and a private key. Together, the keys constitute a key pair. Though the keys are mathematically related, it is not possible to deduce one from the other. The public key is published in a public repository and can be freely distributed. The private key remains secret, known only to the key holder.
- **Authentication:** The act of tying an action or result to the person claiming to have performed the action. Authentication generally requires a password or encryption key to perform, and the process will “fail” if the password or key is incorrect.
- **County:** The office of the Register of Deeds within the designated North Carolina County.
- **Digital signature:** A complex string of electronic data that is embedded in an electronic document for the purposes of verifying document integrity and signer identity. A mainstay of the Public Key Infrastructure (PKI), digital signatures are the most effective method for ensuring non-repudiation for digital documents.
- **Digitized signature:** A representation of a person’s handwritten signature, existing as a computerized image file. Digitized signatures are just one of several types of electronic signatures, and have no relation to digital signatures.
- **Document type definition (DTD):** A document created using the Standard Generalized Markup Language (SGML) that defines a unique markup language (such as XHTML or XML). A DTD includes a list of tags, attributes, and rules of usage.
- **Electronic commerce:** Also known as e-commerce, it refers to trade that occurs electronically, usually over the Internet. Electronic commerce often involves buying, selling, and sharing information, extending both new and traditional services to customers via electronic means. E-commerce allows business to take advantage of email, the Web, and other online innovations to improve the business process and offer consumers more ways to access products, faster information transfer, and, ultimately, decreasing costs.
- **Electronic document:** A Model 3 document which exists as numbers in a computer-readable medium, not as words on a printed page. Since any electronic document is

essentially just a collection of bits (ones and zeros), mathematical processes can be used to encrypt and decrypt the document's contents.

- **Electronic signature:** Any of several methods that links a person to a document or action using electronic data. According to electronic signature laws in the U.S. (including the federal Electronic Signatures in Global and National Commerce Act, E-SIGN, and the Uniform Electronic Transactions Act, UETA), any embedded electronic element can serve as a signature if a person embeds it with the intent to sign.
- **Encrypt:** To apply an encryption key to a message in order to make it unreadable in an effort to prevent unintended use of the information.
- **Endorsement Statement:** As stated in G. S. §47-14(a1)(5), the Endorsement Statement reads as follows: "Submitted electronically by _____ (submitter's name) in compliance with North Carolina statutes governing recordable documents and the terms of the submitter agreement with the _____ (insert county name) County Register of Deeds."
- **Extensible Markup Language (XML):** A computer language used to create markup languages. XML allows developers to specify a document type definition (DTD) or schema in order to devise new markup languages for general or specific uses.
- **Digital signature:** A complex string of electronic data that contains encoded information about a document and the person who signed it. Because they use powerful asymmetric encryption technology, digital signatures are the most secure type of electronic signature.
- **Digitized signature:** A scanned image of a person's handwritten signature, which is captured using special digitizing hardware and stored as a computer file.
- **Hash function:** A mathematical algorithm that takes an electronic document and creates a document fingerprint. The document fingerprint is much smaller than the original document, and does not allow the reconstitution of the original document from the fingerprint. A slightly different document, processed through the same hash function, would produce very different document fingerprint. A hash function helps to secure data by providing a way to ensure that data are not tampered with.
- **Key pair:** A set of keys, including a private key and a public key, used in asymmetric cryptography. Sometimes a key pair will be reserved for specific uses, such as creating digital signatures (signing pair) or encrypting secret information (encryption pair).
- **Metadata:** "Metadata is commonly defined as 'data about data.' Metadata is frequently used to locate or manage information resources by abstracting or classifying those resources or by capturing information not inherent in the

resource. Typically metadata is organized into distinct categories and relies on conventions to establish the values for each category. For example, administrative metadata may include the date and source of acquisition, disposal date, and disposal method. Descriptive metadata may include information about the content and form of the materials. Preservation metadata may record activities to protect or extend the life of the resource, such as reformatting. Structural metadata may indicate the interrelationships between discrete information resources, such as page numbers.” (Source: *Richard Pearce-Moses: A Glossary of Archival & Records Terminology [Society of American Archivists, 2005]*)

- **Nonrepudiation:** Effectively implementing a process in such a way that the creator of a digital signature cannot deny having created it. Nonrepudiation involves supplying enough evidence about the identity of the signer and the integrity of a message so that the origin, submission, delivery, and integrity of the message cannot be denied. Protection of a user’s private key is also a critical factor in ensuring nonrepudiation. The entire Public Key Infrastructure (PKI) industry exists to create and ensure the trust necessary for nonrepudiation.
- **Notary public:** A public official with the authority to acknowledge a signature in a document.
- **Portal:** In eRecording terms, an electronic location where submitters can send their documents for further processing and delivery. A fully featured portal will incorporate specific index rules and information from other tables that assure conformity with the receiving County’s backend recording system. A portal should be capable of receiving various document types from various submitting parties and be able to deliver them to virtually any county, regardless of their back-end recording system or physical location.
- **Private key:** A large, randomly generated prime number used in asymmetric encryption. The private key is used to encrypt a document fingerprint (the result of processing an electronic document through a hash function) to create a digital signature. A private key is generated by its holder at the same time a related public key is created. While the public half of a key pair is made available to anyone who wants it, the private key is only known by its owner, who must keep it absolutely secret to maintain its integrity.
- **Proprietary:** Indicates that software or other employed technology is owned or controlled exclusively by the vendor. These solutions are not transferable to other systems and must be used only on the vendor’s systems.
- **Public key:** A large, randomly generated prime number that is used to decrypt an electronic document that has been encrypted with a private key. A public key is generated by its holder at the same time a related private key is created. Within the Public Key Infrastructure (PKI), public keys are used to verify digital signatures. Public keys are contained in digital certificates, published, and otherwise distributed by the issuing certificate authority (CA).

- **Public Key Infrastructure (PKI):** The framework of different entities working together to create trust in electronic transactions. The PKI industry facilitates signed transactions by using asymmetric cryptography to ensure security and verifiable authenticity. The PKI includes all parties, policies, agreements, and technologies to a transaction. This sophisticated infrastructure allows all concerned parties to trust electronic transactions created within the standards set by the PKI industry.
- **Recorder:** This is usually the Register of Deeds, County Recorder or Clerk of Court depending on the nomenclature and organization of a particular state.
- **Schema:** A method for specifying the structure and content of specific types of electronic documents that use XML.
- **Secure socket layer (SSL):** A security technology that uses both asymmetric and symmetric cryptography to protect data transmitted over the Internet.
- **Signature authentication:** The process by which a digital signature is used to confirm a signer's identity and a document's validity.
- **Signed digital document:** An electronic document that includes an embedded digital signature. The digital signature contains an encrypted document fingerprint that allows anyone receiving the document to verify its validity using the process of signature authentication.
- **Submitter:** An entity that has executed a submitter agreement with a **COUNTY** and is responsible under the terms of said agreement for initiating the transmission of an electronic document, either executed by him or on behalf of others through a **Vendor** to the **COUNTY**.
- **Submitting party:** The entity that originates an eRecording document. This is usually a bank, title company, attorney or anyone that inputs data into a specific template and associates an image and wishes to send the documentation for electronic recordation at the County.
- **Tagged information file format (TIFF):** An image file format commonly used for photos, scanned documents, or other graphics. TIFF images are graphics that are made up of individual dots or pixels. Files in the TIFF format are distinguished by a .tif filename extension.
- **Third party vendor:** Entity that may act as an intermediary or liaison to an electronic transaction. The vendor will usually have some added value to the transaction such as verifying accuracy and completeness of index entries, authentication of the submitting party, or any other County specific requirement.
- **Uniform Electronic Transactions Act (UETA):** A body of recommended legislation drafted in 1999 by the National Conference of Commissioners on Uniform State Laws

(NCCUSL) for adoption by state legislatures. UETA allows electronic documents and digital signatures to stand as equals with their paper counterparts. North Carolina has adopted UETA.

- **Vendor:** An entity that has executed an Electronic Recording Memorandum of Understanding with a **COUNTY** and has accepted the responsibility of transmitting an electronic document from a **Submitter** to the **COUNTY**.
- **Verification and Endorsement:** Under G. S. §47-(a1)(5), a document transmitted electronically contains the submitter's name and endorsed by submitter in accordance to G. S. §47-14(a1).
- **Wet signature:** An original representation of a person's name applied to a document. Wet signatures are often highly stylized, sometimes bearing little resemblance to the name they are supposed to represent.

ADDENDUM B

FREQUENTLY ASKED QUESTIONS (FAQ)

- 1. What are the three proven methods of delivery in eRecording?**
- 2. How does the size of a county affect its ability to participate in eRecording?**
- 3. What are the minimum requirements to implement eRecording in a county of any size?**
- 4. What other requirements would there be?**
- 5. What document types can be electronically recorded?**
- 6. At which models can documents be received?**
- 7. What is a Smart Doc?**
- 8. Why are standards important?**
- 9. What is the relationship between URPERA, UETA and E-SIGN?**
- 10. What are the implications if Electronic Recording Commissions or state agencies overseeing the commission or committee adopt standards that are not aligned with the standards adopted by other states?**
- 11. What types of output are generated by an Electronic Recording Commission?**
- 12. Will private industry solely drive the standards based on early adopters and the information they have already accumulated, or will it be a collaborative effort by the early adopters from across the nation or state in both the private and public sectors?**
- 13. What are significant national standards that guide eRecording today?**
- 14. What is MISMO's relevance in eRecording?**
- 15. What is PRIA's relevance in eRecording?**
- 16. How much security is needed in eRecording?**
- 17. What are the differences and benefits of digital signatures and digital certificates in eRecording?**
- 18. Are digital signatures and electronic signatures the same?**
- 19. What is the difference between a digital signature and a digitized signature?**
- 20. What kinds of electronic signatures should be used? For which signatures?**
- 21. How are electronic and paper documents meshed together?**
- 22. Do current indexing standards also apply to electronic documents?**
- 23. How can costs be reduced and controlled?**
- 24. Are there more fraud concerns with electronic recording?**

25. What is verification and endorsement of an electronic document?

1. What are the three proven methods of delivery in eRecording?

The three methods are point-to-point-integration, third party vendor, and a portal.

In the beginning when eRecording was a new concept, the third party vendor method was popular due to the lack of document preparation software available at the submitter's site.

As eRecording's popularity caught on submitters sometimes found it beneficial to eliminate the costs of a third party vendor and develop a point-to-point integration directly with the county. This was typically true with larger counties where greater recording volumes are common.

With many submitters trying to send to many counties and not wanting to develop unique integration and data schemes for each, the concept of a portal was born. The portal was designed to be a central clearinghouse for submitters and counties. A submitter can deliver various documents intended for several different counties nationwide to the portal. The portal has the ability to verify that specific county index standards have been met and then deliver each document to the specific county for which it is intended.

2. How does the size of a county affect its ability to participate in eRecording?

Because there are many methods in which to participate, a county's size has little bearing on its ability to implement eRecording. A small county that has Internet access could use a web services program to receive and return documents. A medium or large county that has more volume could use a vendor solution or agree to a point-to-point integration directly with the submitter. A portal could be used with any size county, since the portal doesn't care or factor in the size of a county to perform its functionality, or to deliver and return recorded documents from that county.

3. What are the minimum hardware requirements to implement eRecording in a county of any size?

At a minimum, a county would need to have a server with enough disk space to enable a web services program. This program would typically be developed and provided by a vendor or portal solution at little or no cost to the county.

4. What other requirements would there be?

The county would also need to have access to the Internet and have a web browser such as Internet Explorer, which is usually already included in the computer's packaged software when the unit was purchased.

5. What document types can be electronically recorded?

All document types lend themselves to electronic recording. Plats or maps filed electronically may require special handling.

6. At which models can documents be received?

Documents that can automatically be created by a template and have embedded index data submitted with the recording payload, and can be electronically signed and notarized, can be received by a register of deeds if the register of deeds system is capable of accepting Model 3. Examples of these “Smart Docs” would be Satisfactions and possibly Assignments.

Documents that require the original executed instrument to be recorded lend themselves to model 2 recording since an actual copy of the document with wet signatures must accompany the index data. Examples of this would be Deeds and Deeds of Trust.

7. What is a Smart Doc?

A Smart Doc is found only on Model 3 transactions. It gets its name from the fact that a human doesn't need to view or handle it for it to be recorded. Smart Docs contain all of the necessary information to create index entries and to electronically create a document that can be recorded. This is accomplished by virtue of the submitter organizing and labeling the data payload in a standard format that the recorder also subscribes to.

8. Why are standards important?

Standards are important because they allow various parties to communicate and understand each other in a predefined manner. Without standards, there would be constant interpreting and deciphering of information. In the eRecording world, standards allow each party to organize and submit data to the other in a universal manner, without having to employ the use of custom integration points, and in order to facilitate interstate communication.

9. What is the relationship between URPERA, UETA and E-SIGN?

E-SIGN and UETA are federal and uniform state laws, respectively, enacted to enable electronic commerce. While E-SIGN covers some additional issues, they are complementary acts. They are similar in their application to electronic documents and electronic signatures, based on voluntary agreement between parties. Both are self-implementing. Between them, they remove barriers on both interstate and intrastate levels. E-SIGN explicitly preempts certain state laws that do not conform to E-SIGN, even where a state enacts UETA.

URPERA is a follow up act to UETA the purpose of which is to clarify ancillary recording issues. It also establishes a method for adopting standards on a state-wide basis that has the potential for implementing uniform standards nationally.

10. What are the implications if Electronic Recording Commissions or state agencies overseeing the commission or committee adopt standards that are not aligned with the standards adopted by other states?

Since mortgage lending and title insurance have become national businesses that are utilized by North Carolina citizens, this is a significant question. Adopting multiple standards that are not aligned will result in higher costs for both document submitters and county recorders. Computer systems for mortgage lenders, attorneys, settlement agents, title insurance companies and county recorders will have to be designed to accommodate multiple sets of standards. Each different set of specifications will need to be mapped to the

MISMO standards used by the industry. Even then, with incompatible specifications, mapping may be inadequate.

Current national standards are driven by the private sector needs of interoperability among trading partners. Standards developed by PRIA reuse industry (MISMO) architecture, structure and data points. Likewise, MISMO reuses PRIA standards for those pieces unique to recording.

11. What types of output are generated by an Electronic Recording Commission?

Document deliverables can be in two forms. One is to generate the standards, even if adopting from sources such as PRIA, in the format of XML Document Type Definitions (DTDs) or schema, data dictionaries, implementation guides, etc. The other is to issue compiled references to adopted specifications, citing the source and location of the specifications adopted.

12. Will private industry solely drive the standards based on early adopters and the information they have already accumulated, or will it be a collaborative effort by the early adopters from across the nation or state in both the private and public sectors?

The latter. Standards development has already been a collaborative effort, both by trading partners in the private sector and county recorders. However, the collaboration includes more than early adopters. A number of large entities have participated in the standards process even though they have not yet implemented electronic transaction solutions.

13. What are significant national standards that guide eRecording today?

PRIA eRecording; PRIA Notary; MISMO Closing, Servicing, Origination, Request and Response envelopes, eMortgage SMART Document, eMortgage eRegistry, eMortgage ePackage; PDF, TIFF; XML.

14. What is MISMO's relevance in eRecording?

MISMO is the primary standards setting body for the financial services organizations where the lending process begins and whose work efforts result in recordable documents. Their standards will be used by those organizations to create documents and share data. Since this group includes those who create the vast majority of documents to be recorded, their standards will be a major factor in documents processed by county recorders.

15. What is PRIA's relevance in eRecording?

PRIA is a public/private cooperative entity with both recorders and submitters among its members. Its mission is to create and maintain standards. Four technical standards specific to electronic recording by PRIA have been developed. Two are envelopes for submitting and returning recordings. A third is the specification for the document information. The final specification is for notarial information included in notarial certificates and incorporates notary signatures and commission information.

The PRIA technical specifications were developed in close coordination with the private sector (MISMO) to ensure the interoperability of the technical standards. In fact, PRIA reuses a number of the data elements developed by MISMO, as well as the MISMO

architecture. In turn, MISMO has adopted the PRIA data elements specific to recording for incorporation into its data dictionary and technical specifications.

Ultimately, widespread adoption of a standard will facilitate electronic commerce in the real estate finance industry. Neither the private nor the public sector can afford applications that accommodate different interfaces with each different trading partner or customer. PRIA offers a universal interface for recorders that submitters can rely on.

16. How much security is needed in eRecording?

Security is a matter of quality rather than quantity. The quality must be sufficient to protect the assets to the degree that it covers the risk inherent in the process. Once completed the documents will be public record, so protection against prying eyes is not a high priority. On the other hand, documents must be secure from interception that results in their being delayed or not delivered, from substitution by different documents, or from alteration. Because recordings include payment of fees and taxes, the payment system must be secured.

Recorders need to prevent viruses, worms, Trojan Horses, and other malicious software from infecting their networks and systems. They also need to ensure that unauthorized parties do not gain access to the parts of their networks that are not authorized to be accessed by the public.

17. What are the differences and benefits of digital signatures and digital certificates in eRecording?

Digital signatures enable both the recorders and the submitters to determine whether a document or set of documents was altered so they can decide whether or not to continue the process or rely on the resulting recording. While digital signatures require signers to use a key they control to complete the signature, the resulting signatures do not identify the signers in the same manner that a signature on a paper document is identifiable.

Digital certificates can provide a model of certainty that the signers are who they claim to be, thus providing a degree of trust. From a security aspect this can be an important tool insofar as the recorders can use it to decide from whom to accept documents. Conversely, submitters or other parties can determine that particular recordings are authentic when documents are returned from the recorder's office with endorsement of recording information.

18. Are digital signatures and electronic signatures the same?

Yes and no. A digital signature is a kind of electronic signature. Not all electronic signatures are digital signatures in the same way not all pens are fountain pens.

19. What is the difference between a digital signature and a digitized signature?

As described in the Glossary found in Addendum A:

Digital signature: A complex string of electronic data that contains encoded information about a document and the person who signed it. Because they use powerful asymmetric encryption technology, digital signatures are the most secure type of electronic signature.

Digitized signature: A scanned image of a person's handwritten signature, which is captured using special digitizing hardware and stored as a computer file.

20. What kinds of electronic signatures should be used? For which signatures?

This is a matter of agreement between parties, except as to government entities that may have the authority to establish performance standards for signatures under certain circumstances. Even so, government entities need to exercise caution that one technology is not given a higher legal standing than others. E-SIGN claims preemption in such cases.

21. How are electronic and paper documents meshed together?

The concept of "meshing" electronic and paper documents together does not really exist. Once the electronic document is received into the register of deeds system, the process of calculating fees, assigning time, book & page, instrument numbers is the same as for paper documents.

Depending on the model of the electronic document, the image may be transported automatically into the register of deeds system for public retrieval along side the paper document which was scanned by register of deeds staff.

22. Do current indexing standards also apply to electronic documents?

Registers of deeds have the same responsibility for indexing documents received electronically as paper documents received in person, by US mail, and by express methods. Registers must insure that electronically filed documents include that the grantor/grantee data are indexed according to North Carolina Minimum Indexing Standards. Data submitted by the preparer must be verified by the register of deeds and edited to comply with the indexing standards.

23 How can costs be reduced and controlled?

One option being studied is the establishment of a "portal" that would accept documents submitted electronically from ANY system and transmit those documents to the appropriate register's office, no matter what vendor was used for its back end system. This concept would eliminate the need for specific software between a submitter and each recorder with whom he or she files. Different versions of the "portal" concept are being used in other states, some more successfully than others.

24 Are there more fraud concerns with electronic recording?

There is less chance of a document being altered at the recording counter or en route to register of deeds offices than might exist during the prior activities which occurred in the attorney's or title offices. Moreover, intentional fraud is a moral issue and will not be controlled by recording statutes or methods.

25. What is verification and endorsement of an electronic document?

Under G. S. §47-14(a1)(5), with respect to a document submitted by a trusted submitter, the digitized image of the document as it will appear on the public record contains the submitter's name and endorsed by the submitter in accordance to G. S. §47-14(a1).

ADDENDUM C

eRecording Models Explained

From the PRIA I-Guide©

2.3 eRecording Models

Electronic recordings, whether as pilot projects or live production initiatives, have occurred in twenty states. From these efforts, three distinct models have emerged. The models are referred to as Models 1, 2 and 3. Each has distinctive characteristics. Each also brings certain benefits to the submitters.

Over time the improvements in delivery methods and document formats have improved the processes as well. From scanned paper documents, to electronically-signed images of the documents wrapped with XML data and securely signed, to completely electronic, XML-integrated documents using electronic and digital signatures, these models bring continuing benefits to participating recorders and document submitters. Ongoing progress with increasing value from added benefits are expected as mortgage, legal and recording industry standards are implemented.

2.3.1 Model 1

Description

This model is a new extension of the paper-based closing or payoff processes. Documents are prepared and printed. The parties sign and notarize the paper documents with ink signatures. When complete, the signed and notarized paper documents are scanned and electronically sent to the recorder with required endorsement of submitter. Transmission is done by the submitting parties logging on to the recorder's computer system over a secure network after first identifying, or authenticating, themselves to the recorder's computer. The recorder makes the same determination of recordability as with paper documents, visually inspecting them for such things as signatures and acknowledgments as well as determining the recording fees. Fees are usually paid from an escrow account the submitter maintains with the recorder.

Once the recorder accepts the documents for recording the scanned image is "burned" with the recording information, including recording date and time as well as the unique recording reference number, such as book and page number or instrument number. Indexing is performed by the indexing staff of the recorder's office, as are paper documents. A copy of the recorded images is returned to the submitter. Usually a recording receipt, together with the recording endorsement data, is returned to the submitter, who uses the data to create and print a label with the recording endorsement information. The label is affixed to the paper document, which is then processed as usual by the submitter. In other jurisdictions, the paper document is fed through a printer and the recording endorsement information is printed on document (usually on the upper, right-hand corner of the first page).

In jurisdictions that use Model 1, such as Orange County, California, and Maricopa County, Arizona, the average elapsed time for the process is usually under an hour from the time the recorder receives the image until the receipt and data are returned to the submitter.

2.3.2 Model 2

Description

Model 2 recordings may be paper or electronic based. A document image whether from a scanned paper document signed and notarized by ‘wet ink’ signatures or from an electronic document electronically signed and notarized, is wrapped in an XML wrapper containing the data necessary for processing, indexing and returning the document. In the case of a scanned paper document, Model 2 further extends Model 1 by adding data that improves the process, specifically the indexing process in the recorder’s office. In the case of an electronic document, it begins to improve the process for the settlement agent, lender or loan servicer submitting the document.

The model may support one or more of a number of graphics formats. Uncompressed TIFF (Tagged Image File Format) images are commonly used, because this format preserves the image in the most accurate and legible form.

The recordable documents are generally delivered to the county recorder’s site by whatever means the parties agree, including hypertext transport protocol secure (HTTPS), web services, file transport protocol (FTP) and even email. Most counties require some authentication of the submitter, typically based on an account and personal identification number (PIN), although some use digital signatures and certificates in lieu of, or in addition to, the former. The documents are stored in a secure area on the recorder’s website until the recorder’s system retrieves them.

Once imported into the recorder’s system, the recorder’s legacy system handles the recording functions. In this case the system imports the data from an XML wrapper, including index data. The recording process is partially automated, but the image must be visually inspected to determine that it meets recording requirements as well as possibly to validate against the data in the XML wrapper. The indexing data in the embedded image is not linked to the index data in the XML, so the recorder has no automated means to verify that it is the same.

If a document meets the requirements and contains the required endorsement of submitter, it is recorded. The recording information is “burned” onto the image and returned to the submitter by means agreed upon by the parties. In some jurisdictions that use Model 2, the electronic recorded document is embedded into an XML wrapper with the recording information added so that the submitter can use the data in its internal processes.

The average elapsed time from receipt to returning the recorded electronic documents is about five minutes for Broward County, Florida. That compares to about five days for similar closing

documents delivered by settlement agents. A verage turn around for mail-in documents is about seven days.

2.3.3 Model 3

Description

In a number of counties electronic reconveyances of deeds of trust and satisfactions of mortgages are prepared by loan servicers and electronically submitted. Under Model 3, these real estate documents are generated on a vendor's document preparation system in XHTML (extensible hypertext mark-up language) format. The document preparation person logs on to the system and enters the information necessary to complete the generation of the document. Once the document has been generated, the person signs it if she has the authority, or notifies the person with signing authority to sign. Secure access is required for all parties that must sign the document because signing is done by digital signature.

Once the documents are electronically signed and notarized and endorsed by the submitter, they are released for recording. The document preparation system compares each document against recording rules to ensure its recordability, and then calculates recording fees. Documents may be submitted in batches. Submission is by secure hypertext transport protocol (HTTPS) through the vendor's recording server to the recorder's office.

Documents received at the recorder's system are re-checked against the rules to determine whether or not they may be recorded. If not, they are returned to the submitter. Otherwise they are accepted for recording and the data for recording is extracted from the documents and passed to the legacy recording system. The endorsement data is received from the legacy system and entered onto the respective documents in XML format. If required, the XHTML is transformed to TIFF images for the recorder's archives and the XHTML documents with the recording endorsements are returned to the submitter.

Fee payment information is passed to the legacy system after the rules determine that the recording fees are correct. The recorder collects the fees from escrow accounts maintained by the respective submitters, or by Automated Clearing House (ACH) payment processing.

The average turn around time is approximately 30 seconds from the time the recorder receives the document until the recorded document is returned. This time includes the entire process, from quality control verification to indexing, when run in an "unattended" or "lights-out" mode.

Characteristics of different eRecording Models

	Model 1	Model 2	Model 3
Document Type	Paper closings are scanned as TIFF images; no data is associated with the TIFF image. The recorder views the TIFF images to process the submission.	Electronic or paper closings are supported. The electronic document, whether image or other format is embedded in an XML "wrapper" of index data and other information. The recorder processes the submission primarily from the data "wrapper." The recorder also has the option to view the document to validate data or image quality, or review the document to meet other requirements.	A single electronic file with both the signed document and indexing data is submitted and able to be processed by the recorder. Currently the XHTML format (XML data + HTML formatting) is used, or other similar formats, such as MISMO's SMART Doc format or PDF's Intelligent Document, that incorporate the XML data and link it to the content displayed
Signature Type	Ink signatures for borrowers and notary; documents are then scanned.	Electronic signatures (holographic signing/stylus & signing pad)	Current adopters are using digital signatures and certificates for signers, notary and recorder. This model supports other forms of electronic signatures.
Security	Virtual Private Network (VPN)	Digital Signature and Certificate (Closing Agent and Recorder) / SSL (Transmission)	Digital signature and certificate used as a tamper-evident signature for the document and for access control identification for transactions / SSL (Transmission)
Preparer	Title companies, Closing Agents and Lenders scan paper & transmit images.	Title companies, Closing Agents, and Lenders transmit 2 files in one electronic record: document images and XML data	Currently title companies and lenders adopters prepare electronic documents in XHTML format; it supports preparation in compatible formats that provide the functionality of this model.
Recorder	Traditional processing; but no paper. Recorder examines, records, indexes and archives TIFF images	Recorder examines, records and archives images; automated indexing by extracting XML data (QC process only)	All processes can be automated, including examination and indexing; or, the recorder can choose manual processing
Recorded Document	Recorder transmits recorded TIFF ("burned") copy; label data sent also for paper docs	Recorder transmits recorded image ("burned") to preparer	Recorder's system adds recording information to the electronic document as XML data for use by the preparer; converts the recorded electronic document to TIFF for archiving
Payment	"Draw-down" or escrow account for payment	"Draw-down" or escrow account for payment / ACH transaction	"Draw-down" or escrow account; debit account; ACH transaction

e.

Benefits from different eRecording Models

Model 1	Model 2	Model 3
Reduces recording time / Improves the amount of documents processed.	Reduces recording time / Improves throughput	Reduces recording time / Improves throughput
Reduces costs to recorder only.	Reduces costs to the recorder and title company, closing agent, or lender.	Reduces costs to the recorder and title company
Improves productivity to recording office only.	Improves productivity for both document submitter and recorder.	Improves productivity for both document submitter and recorder.
Improves customer service and satisfaction	Reduces the probability of documents being altered after transaction is closed/ Encrypted "wrapper"	Reduces the probability of documents being altered after transaction is closed / Secure signatures
	Uses open and non-proprietary systems and formats	Standardizes processes and formats
	Improves customer service and satisfaction	"SMART" documents automate processes and systems
		Uses open and non-proprietary systems and formats
		Improves customer service and satisfaction

Issues concerning different eRecording Models

Model 1	Model 2	Model 3
Complexity of the process of scanning and labeling for submitters	Images are unintelligent	Payment and electronic transaction disconnected; adds complexity to process.
TIFF image is unintelligent; data is not extractable	Electronic document and XML data are disconnected; possible need for reconciliation.	
Costs increase to submitters; may be greater than or equal to paper	Closed system architecture and proprietary software	
Closed system architecture (proprietary)	Payment and electronic transaction disconnected adds complexity to process	
Payment and electronic transaction disconnected; adds complexity to process	Lacks embedded business rules	
Costs for proprietary software and data connection	Process and transport are cumbersome.	
Lacks embedded business rules		
Process and transport are cumbersome.		

ADDENDUM D

Survey Results and Comments

Government, Public, and NC Counties Liaison Sub-Committee Report

North Carolina's passage of the Uniform Real Property Electronic Recording Act (G.S. 47-16.1) allowed for the electronic recording of documents statewide. Before statewide implementation could occur, however, the interests of many stakeholders had to be considered. That was the mission that drove the Government, Public, and NC Counties Liaison Sub-Committee in its work. The committee began by trying to determine what stakeholder groups had an interest in Electronic Recording, who would be affected by it, or what other processes would be impacted by its implementation.

An obvious starting point was to ascertain the opinions of the 100 county Register of Deeds in North Carolina regarding electronic recording and any specific concerns they would have that might prevent participation in the process. Since the statute does not mandate electronic recording, the committee felt the full Electronic Recording Council (ERC) should be aware of, and have an opportunity to address concerns that Registers had to ensure the greatest possible participation in electronic recording. Without a majority of Registers being comfortable with and willing to implement electronic recording, it will never succeed in this state regardless of how much other stakeholders want it. An online questionnaire was sent to all Registers in the state asking for their input. There were several issues which came out of the responses received that are perceived obstacles from the Registers' viewpoint. Those include priority of electronic recordings versus paper documents, collection of recording fees, document security, costs to the county, lack of education about electronic recording, and software integration among others. Graphs of Register responses to survey questions are attached to this document.

Other governmental entities also were identified as stakeholders in the recording process. The NC Tax Assessors Association was contacted because in many counties deeds that are to be recorded must go through the tax office before recording. In numerous counties, taxes must be paid before recording, or the tax office must place a pin number or some sort of stamp indicating that no taxes are due before that document can be recorded. Some thought needs to be given as to how this process will be affected by the electronic submission and acceptance of documents in the Registers office. As was done with the Registers, an online questionnaire was sent to Tax Assessors. Questions asked of this group were:

- (1) What is your awareness of e-recording?
- (2) Does your county have any current activity in e-recording?
- (3) What obstacles do you see to implementing e-recording?
- (4) What concerns do you have?
- (5) How do you see e-recording fitting into your business plan?

Results of the survey sent to Tax Assessors are attached to this report.

The traditional method of document recording allows for a document to be hand-delivered or sent via mail or courier along with a check attached for recording fees. Along with electronic submission of documents comes the need to look at other ways to accept payment of recording fees. The NC Finance Officers Association was contacted to seek feedback regarding the different possible methods of payment and costs associated with each. Copies of the questionnaire and results are attached to this report.

Survey questions were also sent to the NC Department of Transportation, Property Mappers Association, and the NC Association of County Commissioners. Responses received from the NC DOT indicated the primary concerns from this agency are document security, electronic seals, and document file formats used. Even with these concerns, the DOT generally saw electronic recording as beneficial in reducing time spent and paperwork generated on highway projects. There were no specific concerns listed by Property Mappers who responded to the survey and the NC Association of County Commissioners did not respond to the survey request that was sent.

Not only did the committee see the importance of getting input from various government and county entities which would be impacted by electronic recording, but the committee also wanted to gain some private industry perspective. That perspective would be most valuable from those stakeholders who submit the largest volume of paper recordings currently and will be the primary users of electronic submission methods in the future. These two groups are financial institutions and attorneys. Currently, financial institutions throughout the United States submit mortgages and related documents. Because of North Carolina's status as a leader in the banking industry, being home to two of the nation's four largest banks, the committee felt North Carolina bankers could give us a realistic picture of the banking industry's acceptance of electronic recording and specific concerns that the ERC should consider when implementing standards. Again, a questionnaire was sent to the NC Bankers Association but no responses were received.

Attorneys who practice law in North Carolina work in firms that range in size from one person to mega-firms that employ large numbers of attorneys in regional offices all across the state. The most practical way to solicit input from practicing attorneys throughout the state was to send a questionnaire to the Real Property Section of the NC Bar. This would target those who perform real estate work as a large portion of their practice. An on-line questionnaire was sent to their listserv. Concerns gathered from the responses received include the ability to do online title updates, document security, prevention of fraud, confirmation of recording status, and the ability of out-of-state firms to take business from local attorneys.

From the results compiled by the committee, there are various lessons to be learned. First, the need for more education about electronic recording is great. The committee found that among many of the stakeholder groups, there was misinformation or skepticism about the prospect of electronic recording because of a lack of knowledge about how it would work. Second, Registers are much more receptive to the idea of electronic recording than was previously believed. As with any change, the expected reaction is one of resistance or at least some initial reluctance. However, a clear majority of Registers in the state are very receptive to some form

of electronic submission of documents. Third, the private industry is more skeptical of the idea than many previously believed. This is particularly true with Bar members. Not only through the responses given to the questionnaire, but also through conversations with practicing attorneys throughout the state, the committee found many questions and concerns. The encouraging news is that most of the concerns voiced came from lack of knowledge about how the process works. It is hoped that education in this area would change many of those perceptions.

The committee went to great lengths to include as many stakeholders as possible in the final report. As will be seen from looking at the responses from the various groups, participation among some stakeholder groups was much higher than others. However, all groups were given the same opportunity to submit responses and were encouraged to provide input. The committee's final goal was to engage these groups with the hope that their input would help shape the final outcome of a product that will be beneficial to all involved and will enable business to be done more efficiently in North Carolina.

Respectfully submitted,

The Government, Public, and NC Counties Liaison Sub-Committee of the
North Carolina Electronic Recording Council

N.C. RoDs Who Plan to Spend Funds to Become eRecording-Capable

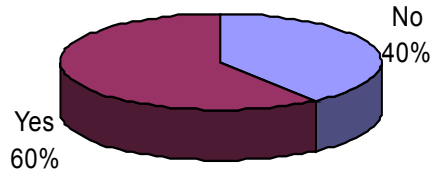

N.C. RoDs Who Plan To Offer eRecording

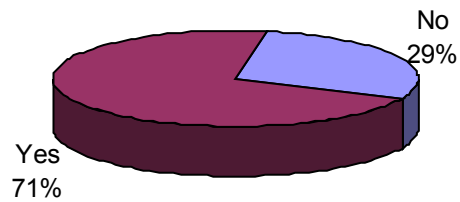

N.C. RoDs Who Plan to Stop Printing Indexes

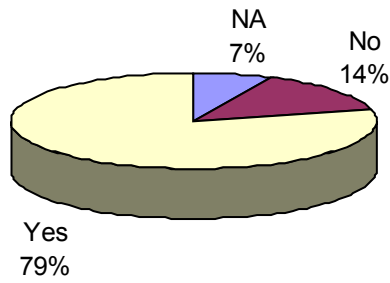

N.C. RoDs Who will Purchase Vendor-Supplied eRecording Software

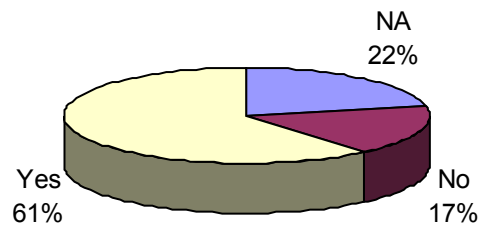

N.C. RoDs Offering, or Plan to Offer, Website Search

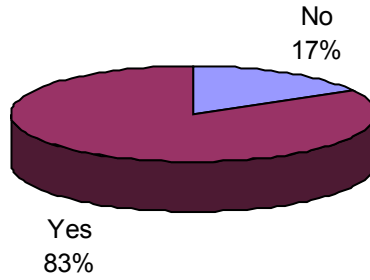

N.C. RoDs offering Online Data Within Their Office

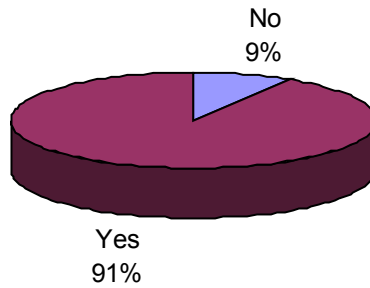

Finance Officer's Survey

Since GS 159-32.1 authorizes a ROD to accept electronic payment, what, in your opinion would be the best method of accepting electronic payment?

By wire from Bank/Lender directly to the County for payment for recording fees of an electronic document?

This would be acceptable.

Don't really want department giving out our bank info.

A wire would be fine. However, each Bank/Lender would need to provide an e-mail notification to Finance Dept. contact with info regarding the particular transaction. Otherwise, it will be very difficult to track. The Bank/Lender could provide simultaneous notification to the ROD.

Through an ACH payment that Finance would draft. I do not want to give out County bank info to everyone that may want this option. They can complete the EFT draft info and give me their info and I can process. We accept water payments through this method now.

The choice of best method depends on perspective. From a simple Finance perspective, ACH is typically less expensive per transaction.

Will not accept e-payments at this time.

The best method of accepting electronic payment would be by wire from Bank/Lender directly to the County.

Establishment of an escrow account depositing various monies from various sources for recording fees?

I think this would be too cumbersome.

N/A

Unless mandated, I would not use this method.

Establishment of an escrow account depositing various monies from various sources for recording fees?

Do not care for this method.

Will not accept e-payments at this time

I do not like the idea of an escrow account. I have too many accounts to maintain at this time.

Yes, banks could establish escrow accounts for their customers.

Via credit card payment?

This would be the most convenient option for the customers.

I'd rather take credit card payment.

Will not accept e-payments at this time

If a credit card payment is made, again it should be the responsibility of the person requesting the recording and should not be any cost to the county.

Would this direct payment for recording go directly into the general fund or in a line item dedicated for the ROD use?

General Fund

The fund would go to an account/line item for the ROD

Into the ROD revenue account, which is regarded as a general fund revenue.

Recording fees are part of the General Fund & should remain non-restricted revenue. The ROD Technology & Preservation Fund should provide funds necessary to implement any new equipment required to accept electronic documents.

This would go in the same ROD fees revenues as all other recording fees.

The department would get credit for their sale, but the monies would be available for anyone to use (just as it is now).

The fee would go to the revenues of the ROD.

It would go into the ROD dept in the general fund like any other receipt.

The payment would go directly into the general fund but would be recorded as revenue to the ROD.

Recording fees would be handled as usual - revenue in the General fund, in the ROD center (dept)

Most likely in the general fund unless otherwise required by statute.

Would this require new line items for expenditures and revenues?

We currently do this for the ROD.

A separate account would be fine, such as in the NCCMT.

Not sure I understand this option, but it sounds like it probably would.

Would this require new line items for expenditures and revenues?

That depends on how the law is written. We surely recommend that we continue to use the same accounts as always, that the escrow account is simply a balance sheet entry, not an income statement entry.

Not sure

I don't understand what this means. Escrow for what?

This would not require additional revenue accounts, but the bank would probably charge a fee to set up the account and you would still have to deal with money transferring from different accounts as transactions are processed.

A ROD cannot charge over the uniform fees. What is an estimated amount of a surcharge on a credit card payment?

The county accepts tax payments from 3rd party processor that charges a convenience fee, we get the net amount which is the balance due. The county would not want to pay the credit card fees.

This process is set up through a 3rd party vendor that would charge a fee & remit the ROD 100% of the ROD fee.

County could absorb the cost.

It all depends on many factors including the total transactions for a particular county, negotiated rates, items of deposit, etc.

Our current fee is about 3% of the charge amount. We would only accept credit cards for amounts below \$1,000.

I think this depends on the amount charged; I am thinking we currently pay around 3-4%.

Typically, the surcharge on credit card payments, based on our experience, is anywhere from 1.79% to 2.9% depending on the vendor.

No surcharge can be applied to a credit card fee unless you use a third party to collect the fees for you and then they keep the fee.

Banks do not allow you to impose a surcharge, however you can have a convenience fee like Official Payments charges for tax payments. We would probably use Official Payments for this and their charges are hefty.

The ROD office would have to absorb the costs of accepting credit card payments. typically 2-3% of the transaction. Other County departments are doing this currently as a cost of doing business & as a convenience to their customers to improve customer service & decrease time.

Would there be a fee involved to wire these funds? If so, who absorbs the costs?

The sender would pay the fee

If so, the customer would pay it.

The Bank/Lender may encounter its own banking fees to initiate the payment. The County would not charge a separate fee. However, a Finance Dept. staff member will have to track the receipts as they are deposited into our bank account & report them to the ROD office. (More General Fund costs)

If the customer's bank imposes a fee, then that would be paid by the customer. The County does not get an incoming ACH fee from our current bank.

There is a fee but our local bank would absorb the fee under our current arrangement. If we are charged a fee by the bank, we would like to charge the customer the convenience fee using this method of payment.

The fee would be a line item expense in the ROD office just like it is for all county departments who take electronic fees.

Fees on wires are normally paid by the sender

I do not feel that the County should have to absorb any cost associated with these wire transfers. It should be the responsibility of the person requesting the recording.

Our bank charges us a \$5 fee for all incoming wires. (I would not recommend this for Catawba Co) An ACH transfer would be a cheaper mechanism for the transfer of fund, yet still difficult to manage in Finance & ROD office.

There may be a small fee, but we receive other wire transfers, any costs associated with those are recorded

Would the funds standing in an escrow earn interest and, if so, would the interest be allocate to the ROD budget?

This would be determined by the agreement between the ROD and the party setting up the escrow.

Once again, the ROD will not be the only department with increased processing costs. Finance will bear the burden of account for the transactions and the interest on the special bank account should go to the General Fund. There are many indirect costs (Administration, Human Resources, Safety, Finance, Facility Services, Building Depreciation, Information Systems Management, etc.) Information Systems Management, etc.) in the ROD budget.

Most likely not unless otherwise required by statute because the ROD budget is part of the general fund. The whole general fund gets interest - not each department.

Would the funds standing in an escrow earn interest and, if so, would the interest be allocate to the ROD budget?

We would gladly use the interest to offset any additional fees charged by third parties.

No

For what?

It would depend on the bank as to whether those funds earn interest, and the interest could be allocated back to the ROD office if set up that way.

If paid by credit card, how would the Finance Office handle the surcharge?

Per the credit card company agreements the county could not pass on the fee to the payer.

Same a last answer

The fee would HAVE to be paid by the customer. The county would not subsidize the customer by paying the surcharge.

We do this for several departments.

The ROD budget would have to include a budgeted expenditure line item to absorb the costs.

The County would absorb the sur-charge.

We currently absorb the costs of accepting credit cards for other services.

We would like to charge the customer the convenience of using a credit card to pay this bill. I understand current law does not allow the ROD, therefore, our County ROD does not currently accept credit card payments.

The surcharge would be an expense to the ROD department.

With Official Payments we do not get involved in the fees. It is charged to the person's credit card.

Surcharges can be added, yet it has to be uniform across the County. Our County does not harge convenience fees at this time.

Survey posted on “ptax” list serve for local government tax offices.

Survey questions:

- 1) What is your awareness of e-recording?
- 2) In your county organization, is any form of electronic document acceptance currently taking place?
- 3) Do you foresee any obstacles to implementing e-recording in your jurisdiction?
- 4) How would you use e-recording in your county or in your department's business plan?
- 5) Are deeds required to be reviewed by the tax office before they are recorded? If yes, do you foresee any problem or advantage to accepting those deeds electronically for your review?
- 6) Do you require payment of delinquent taxes before a deed is recorded? If yes, do you foresee any problem or advantage to accepting deeds electronically for your research and certification?

County Name _____

Person Completing Survey _____

Contact email or phone number _____

Please respond by May 2, 2006 and on behalf of the NC Electronic Recording Council, thank you for your time and attention to this request for survey information.

ERC Survey Tax Assessors

1) Awareness	2) Any Form	3) Obstacles	4) How Used	5) Deed Review	5a) Obstacles	6) Pay Rec.	6a) Obstacles
Yes	No	No	Yes	No		No	
Minimal	No	Problems with tax certification	Not sure		All Delinquent taxes must be pd	Yes	Deed needs Parcel #
None	No	Technical Hardware, Software Programming	- - -	No		No	
Minimal	Yes	NO	Business Listing Forms	No	NO	No	No
Minimal	No	Software adaptation	Tax Listing by e-mail	No		No	
Yes	No	Yes, modifying software	BP, Job applications, privilege license ,etc	No		No	
Very Little	NO	Political Obstacles		No		No	
Minimal	Minimal	Unknown	Unknown	No		No	
Not aware of	No	No	Cannot see our processes changing	NO		No	
Article in Popular Gov.	Yes	Yes	Not sure	Yes	No	Yes	No
Minimal	Yes	No	Can't Stop progress	NO		NO	
Minimal	Unknown	Cost	UNKNOWN	YES	No	YES	NO
Richard Davis has served	Not Aware	Process for certifying no delinquent taxes	Issue for Register of Deeds	No		No	
Minimal	No	Costs	Indicate the availability and details	No		No	
None	Unknown	Yes	Review deeds, etc.	No	None	No	None
Minimal	No	No	County small	Yes	County Small	No	
Minimal	Unknown	Resistance to technology		No		No	
Minimal	No	Yes	Not sure	Yes	No	No	None
None	No	Yes, attorney's inability to draw up a deed	TO REQUIRE TAXES PAID	NO		No	
Yes	No	No	Scanning, tax listings	yes	parcel # on deeds	no	
Minimal	No	No	Unknown	Yes	Provision necessary of T/O to review	No	
None	No	None	None	NO	No	No	None
Minimal	No	Money	Make work move faster	Yes	No	No	
None	No	None	To expedite receipts	No		No	
Limited	No	NO	Not sure	Yes	No	Yes	No
None	Yes	No	Documents are scanned	No	Each deed must contain PID #	No	
None	NO	Yes, Funding	Not sure	No	No	No	None

North Carolina Electronic Recording Council
10/20/11

1) Awareness	2) Any Form	3) Obstacles	4) How Used	5)Deed Review	5a) Obstacles	6) Pay Rec.	6a) Obstacles
None	No	Yes		Yes	Need process for delinquent Tax col	yes	Yes, Delinquent Tax certifi.
Minimal	No	Yes, R.O.D. against it	UNKNOWN	YES	Don't Know	NO	
None	No	Yes, Installation of hardware	Not sure	Errors	Errors	No	No
Minimal	No	None Known, we have IT support	Accept Listings, OAE	No		No	
Minimal	Start July 2006	No	Reduce foot traffic/improve Public Access	Yes	No	No	
Minimal	Unknown	Not sure	Not Sure	No		No	
Not aware of	No	No		Yes	No Problem	No	
Minimal	None Known	Cost	Listing Forms and Plats	Yes	Errors	Yes	Errors
Fair	No	Some	Forward documents to other entities	No	Yes	Yes	NO
None	No	No	Possibly save paper work	Yes	Receiving all information required	No	Lawyers did not like it
Minimal	Yes	Yes, Culture change for some	Personal Property abstract filing	No		No	
Some	Yes, BP Listing	Last minute deadline filing	Recording Deeds	No		Yes	
Minimal	No	Yes, T/O required to sign off on deeds before recording	UNKNOWN	Yes	T/O required to sign off on deeds	No	

Land Title Association Survey Results

1. Respondent Type

1. Are you ... (use drop down box for choices)			
		Response Percent	Response Total
	an Attorney	54.5%	12
	a Title Company Representative	40.9%	9
View	Other (please specify in box below)	4.5%	1
Total Respondents			22
(skipped this question)			0

2. Awareness

What is your awareness of Electronic Recording (E-Recording)? For example, what do you know about it and where/how it is happening or not happening?	
1.	Nothing
2.	Yes very aware
3.	Minimal. Not in use or under consideration in my geographic area.
4.	Low
5.	I am aware of E-recording as a result of being a member of the NCBA Real Property Section Council, and having participated as one of their representatives in the mad scramble in July to craft a decent notary law out of the mess that the Secretary presented to the General Assembly. I have also attended a meeting of the NC Advisory Council on Electronic Notary Standards on behalf of NCBA Real Property.
6.	We know that some counties are accepting eRecording for cancellations of Deeds of Trust. Other documents are on the horizon.
7.	Not happening in my counties
8.	I know they are doing it in Mecklenburg County but as to exactly how it works and whether it will hold up against fraud I do not have a good feel for that
9.	I have not paid much attention to it.

<u>10.</u>	I am aware of it. I do not know where it is or is not happening.
------------	--

3. Concerns, Problems, and Obstacles

What concerns and obstacles does your firm or organization have in implementing E-Recording and E-Notarization as an option to the traditional methods of updating and recording documents?	
<u>1.</u>	Fraud
<u>2.</u>	Need to see uniformity across the state and legal assurances that e-recording will have the same effect as paper.
<u>3.</u>	The traditional methods have safeguards created over many, many years. Minor gains in efficiency should not be allowed to unravel a functioning system that protects all parties to a transaction. One needs only look at the AOC civil indexing system to see how much damage can be done by turning over an indexing system to technology experts with insufficient grounding in the legal system being indexed and documented.
<u>4.</u>	none
<u>5.</u>	Implementation in such a manner that it is not cost prohibitive, or restricted to only one vendor; e-notary and e-recording must be acceptable as alternatives to traditional recording methods and not cause additional title issues; sufficient security in transmission of documents to give public confidence in documents as received in the RoD's office;
<u>6.</u>	As a title company in north Carolina we firmly believe that we should not be involved closings and therefore should not be the recording agent.
<u>7.</u>	fraud
<u>8.</u>	Just don't know anything about it.
<u>9.</u>	unsure
<u>10.</u>	Priority of recording, lien and judgment updates, Access to records to know if a notary is certified to take e-notarizations. The ability of various Registers of deeds to understand and to have the necessary equipment and personnel to accomplish this type of recording. We cannot get the Registers to agree on what is acceptable for regular recordings now. I am positive we cannot agree on e-recordings. They are, after all, elected officials who will make their own interpretations of what the law says.
<u>11.</u>	Please see prior answer. In addition I must be able to be certain that something has not been queued for recording prior to my filing and we have a priority issue. We still must check the Clerk's filings so unless the Clerk's records are part of the process, the e-recording in the Register of Deeds is of little help from a lien priority standpoint.

4. Usage of E-Recording

How do you see E-Recording being utilized in the title and settlement industry and among attorneys in the Real Property Section of the Bar?

<u>1.</u>	I hope it isn't!
<u>2.</u>	Slowly and cautiously, based on legal "safety"
<u>3.</u>	White collar crime and fraud are generally on the rise in the realm of real estate transactions. I anticipate increasing claims and losses as our leaders create a system that makes it easier for the criminals to commit fraud.
<u>4.</u>	Will expedite the recording process
<u>5.</u>	once implemented, I see regular use by large institutions to do assignments and cancellations of large volumes of documents; if it becomes available widely, I see multi-site, multi-county transactions using e-recording as an alternative to having to dispatch runners all over the state; I am less convinced that day-to-day real estate transactions will be done electronically for several years to come---there are too many other documents, other than the deed and deed of trust which have to be executed.
<u>6.</u>	For attorneys that are technically setup, the documents can be recorded quickly and efficiently saving time and money, however it could lead to an updating nightmare, as the attorney would not know what else is getting recording ahead of him. Things would be coming in, in such a manner so as not to have an up to the second update before recording.
<u>7.</u>	title companies in NC typically don't do closings. I believe it may be used to facilitate out of state (or what we have known as mail away) closings.
<u>8.</u>	Not sure how I can e-record when I still have to drive to Carthage to update judgments. While I am there I might as well record in person. It will be ok for recordings without judgment searches, but again, I will be in Carthage to record deeds and deeds of trust, so I can record all other items then.
<u>9.</u>	I have no opinion at this time.
<u>10.</u>	For most regular closings, I do not expect or want to see e-recordings. I am sure the large commercial transactions will use e-recordings in the larger or more advanced technologically advanced counties. I cannot see them being used in most rural counties.

ADDENDUM E

Archival Process For Data And Image Preservation

N.C. Office of Secretary of State

**Electronic Recording Council
Subcommittee for Archiving Electronic Data**

Report

***The Management and Preservation of Digital
Media***

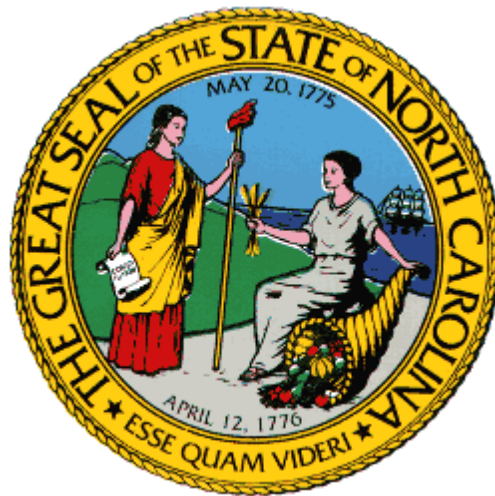

June 22, 2006

Best Practices for the Long-Term Retention of Electronic or Digital Records

With the passage of The Uniform Real Property Electronic Recording Act (G.S. 47-16.1 et seq) in September 2005, the North Carolina General Assembly permitted the electronic recordation of land transactions.

This “Best Practices” document serves to provide guidance to both the practitioners of e-recordation and the custodians of trusted digital repositories who wish to maintain the information electronically over time.

I. The Management and Preservation of Digital Media: An Overview

Digital records have taken over many of the functions that older recording technologies served. Like their older counterparts, digital records contain evidence of government responsibilities, citizen rights, public and private economic activities and financial transactions and obligations, scientific projects, and historical events and trends. The volume, complexity, and pace of the advances in digital media themselves, however, require the careful and consistent management of digital records if accountability and the preservation of digital records are to be assured. The integrity and accessibility of digital records also rest upon planning, documentation, and committed custodianship throughout their life cycle to an even greater degree than with paper records. Digital information is especially vulnerable to changes in software and hardware. Digital storage media, especially access technologies, are also subject to deterioration. Like every other medium or recording technology, digital technology is open to error, misuse, or fraud. In brief, to be available today, tomorrow, and the next century, digital records must have both proper management and long-term (and in some cases, permanent) preservation. For digital records that are deemed permanent or archival, their durability needs to approach that of microfilm.

To help assure the security and preservation of records with enduring historical or legal value, especially in the event of a human-made or natural disaster, microfilm is preferable because it is not dependent upon complex technology. Properly processed and housed microfilm lasts for hundreds of years and can be read with a magnifying lens and light. Microfilm is also an acceptable medium as evidence according to G.S. § 8-45.1 (a). It should also be noted that G.S. § 8-45.1 (b) and G.S. § 153A-436 (f) specifically prohibit the use of “computer-readable storage media” for “preservation duplicates...or for the preservation of permanently valuable records...except to the extent expressly approved by the Department of Cultural Resources....” (See the texts for G.S. § 8-45.1 (a) and (b) and G.S. § 153A-436 in “Best Practices---Legal Admissibility Standards” below.)

Many public agencies and corporate organizations remain ignorant or not fully aware of the complexities of dealing with digital records. Sometimes organizations, for instance, devote greater effort to creating or receiving digital data than to its long-term maintenance and management. Managing digital records and information adequately, maintaining their authenticity, and assuring their legal acceptability---all require an infrastructure containing certain detailed elements. These include policies and procedures; planning; trained staff (including assignment of specific responsibilities for data management to specific staff members, such as digital data archivists or managers, trained for their roles); and physical systems and facilities, including a digital repository.

While there is as yet no viable long-term strategy to ensure that digital information will be readable in the future, one methodology likely to prove valuable in helping assure future accessibility of digital records is to gain control of and preserve information about digital objects and to manage this information in a formal, electronic record-keeping system for collections of digital objects. Currently DOD 5015.2-STD provides specific requirements for software applications that manage digital records. Other similar standards remain in early development. Other choices for digital record-keeping include digital repositories and digital asset management. Consideration needs to be given as well to the use of open source software and open architectures.

The creation and management of a digital repository---whether on an institutional scale or as a local digital storage server, component, or similar device---require attention (detailed further below) to six broad areas or functions:

- **Ingest**, or acceptance of the data or information and its preparation for inclusion in the repository;
- **Storage**, or long-term storage and maintenance of the data with appropriate procedures for preservation and error-checking;
- **Data management**, or maintenance of databases of descriptive metadata, appropriately updated and preserved;
- **Preservation planning**, including updating policies and procedures and monitoring the external environment, including the development of new technologies;
- **Access**, or management of the means by which users find, ask for, and receive data;
- **Daily administration**, including interaction with users, problem-solving, negotiation with data donors, and overseeing performance of the system.

(These functions are based on the Reference Model for Open Archival Information Systems [OAIS]. See: Consultative Committee for Space Data Systems, "Reference Model for an Open Archival Information System (OAIS)." CCSDS 650.0-B-1. Washington, D.C.: National Aeronautics and Space Administration, 2002, and Lavoie, Brian F., "The Open Archival Information System Reference Model: Introductory Guide", In *DPC Technology Watch*. 04-01. Dublin, Ohio: OCLC, 2004.)

Before acceptance, data should be inspected and verified for operational use as the source intended, and for authenticity, integrity, and freedom from computer viruses. Restrictions or other conditions involving confidentiality or privacy, as well as proper retention and disposition provisions, need to be established. Data integrity must also be established through message digests or signatures, assuring that the data itself, its documentation, and all other descriptive and packaging information agree with that provided by the source. Digital validation should follow establishment of the data's integrity. The identity and integrity of the data must be periodically and systematically verified through such mechanisms as the Secure Hash Standard (SHS) and Secure Hash Algorithms (SHA), the designated standard of the National Institute of Standards and Technology (NIST). Long-term preservation and use of digital data also depend upon the preservation of metadata and data documentation.

Organizations must also assemble methodologies, systems of hardware and software, and physical facilities to record, access, document, and protect digital data. Digital media themselves must be regularly tested and sampled for deterioration and continued accessibility. Provision must also be made for conversion or migration to new formats, storage media, and technologies. A digital risk management plan may include regularly scheduled migration of archival digital objects to new media. Care must be taken that hardware and software are maintained that can migrate archival data to new media. Documentation must be created and maintained that records information about all data formats, each type of media, required environmental conditions, processes for maintaining archival characteristics, and efforts to reduce risk. The digital data archivist or manager or a team of specialists should also assess data formats as digital technology advances and plan for formats that will become obsolete. Digital data will not be readable or useable, nor legally acceptable, in the future without active management in this as in every other function listed above.

Detailed, written policies are needed for both active and long-term data management, records retention and disposition, appraisal, preservation, and disaster preparedness and recovery. Policies and procedures should address issues of confidentiality and privacy. They must also be reviewed periodically and audited regarding enforcement and compliance.

Physical maintenance of digital records, finally, requires stable, secure, environmentally controlled storage and operational facilities within a larger framework that includes offsite facilities for storing duplicate copies of digital media as well as vital records (including microfilm copies of vital records kept in paper format), and system backup copies that will be available after a natural or human-made disaster.

II. Best Practices for Archiving Electronic Records:

- Maintain at least 3 to 4 copies of the record. One copy should be designated as the preservation master, one copy should be designated as the access record, and one record should be designated as back up. Having four copies allows margin should one copy fail.
- Provide bit preservation storage of the record. If preservation strategy includes migration of data, keep original bits for future solutions.
- Work from a copy of the material when migrating or making changes. Information may be lost during migration. If you work with the original copy, the information may be permanently lost. Additionally, a preservation method may develop for the material which you could employ at that time.
- Metadata, checksum algorithms and checksums as well as data must be maintained and bundled together in order to preserve the integrity and admissibility of the data.

Best Practices-Policy and Procedures

- Create and update policies and procedures defining proper development, maintenance and use of the system. It should be available in electronic and hard copy print formats. It should include the metadata file required to interpret the records as well as technical components and characteristics necessary for reading, processing, accessing, using and processing of records.
- Periodic training, regular retraining and support programs that insure staff understand the policies and procedures.
- Up-to-date documentation about all permanent or archival electronic records sufficient to: Specify all technical characteristics necessary for reading and processing the records, identify all defined inputs and outputs from the system, define the contents of the files and records, determine restrictions on access and use, understand the purposes and functions of the system.
- Describe update cycles or condition and rules for adding information to the system, changing information in the system, or deleting information.
- Establish a security back-up routine based on best practices, e.g. daily, weekly and monthly or as frequently as needed to protect the information assets. Back up materials should be stored off site in case data restoration is needed.
- Establish secure off-site storage for all system password and operating procedure manuals e.g. a bank safety deposit box.

Best Practices-Integrity of Data

- Metadata must be collected about the record and maintained with the record either embedded in it, or can be maintained separately. Descriptive metadata is used for the indexing, discovery, and identification of a digital resource. At a minimum, your descriptive metadata for land and property transactions should include the grantor/grantee names, title-file, date-file time, book and page, and description. Preservation or administrative metadata is information that is needed for the management of the digital object, which includes information regarding access and display and rights management. Administrative metadata that needs to be collected

includes the file format, document type e.g. deed, mortgage, pleading, the operating system, software configurations, the rights/security, and versions thereof.

- If special authority is needed to access the information, indicate who has that authority, the data type (e.g. document or photograph)
- If security is applied, include method of digital fingerprinting so it can be recreated and compared to the original fingerprint, e.g. digital certificate.
- If you elect to accept digital certificates, you should have a migration strategy in place and have some method to verify the certificate in the future so that it is preservable and upwardly migratable. As part of your migration strategy, a digital fingerprint should be created at the beginning and at the end of the migration to ensure that the numbers produced from the algorithm are the same. If the two “fingerprints” match, then no error occurred during the transmission or migration.
- Integrity of the record: Information can be lost during migration or when media corrupts. To ensure that the data does not and has not change, a computer generated digital fingerprint should be performed e.g. a Cyclical Redundancy Checksum, CRC, or an cryptographic hashing algorithm such as a MD5 hash or other hashes. A CRC verifies the transmission of the document but not the document itself. A digital fingerprint is a unique to each document and verifies the integrity (unaltered state) of the document. When auditing the information or storage media, reproducing the digital fingerprint can determine if data has been lost.
- For admissibility of records, the content, context and structure should be preserved.

Best Practices-System Parameters

- Document the system that produced the record including the system hardware and software versions used to create the record. Policies and procedures for all aspects of system operation and maintenance, including procurement, data entry, quality control, indexing, corrections, expungement, redaction, back-ups, security, migration, application of safeguards to prevent tampering, and unauthorized access and printing.
- The following items should be maintained for archive entries:
 1. All system equipment specifications
 2. Contact information for manufacturers and vendors.
 3. All system equipment specifications.
 4. A description of all hardware and software upgrades to the system, including date of maintenance and version of software along with setting change, date, time, and name of operation.
 5. Technical and user operation manuals.
 6. All policies and procedures related to access to and security of the records.
- Any changes made to the system or the process should be documented.
- System should be capable of providing audit trails and system security. Effective audit trails can automatically detect who had access to the system, whether staff followed existing procedures, or whether fraud or unauthorized acts occurred or are suspected.
- A migration strategy should be established and implemented for regular recopying, reformatting and other necessary maintenance to ensure the retention and usability of electronic records throughout their authorized life cycle. Migration needs to maintain the content of the records and any associated metadata required to interpret the records including: record format or layout, contextual elements, and the data's relationship to other data.

- Document the controls that monitor the accuracy and authenticity of data, the reliability of hardware and software, and the integrity and security of the system.
- Use open-source software.
- Use preferred file formats: such as rich text format (rtf), .pdf, TIFF, version 6.0, JPEG2000, SQL database.
- Copy immediately onto new media any permanent or archival electronic records stored on media with 10 or more permanent errors per volume
- Copy all permanent or archival electronic records onto new media before the media is 5 years old. While manufacturer specifications might promise a longer lifetime of a media, independent test show media degradation as early as five years. Additionally, new software technologies usually come to market within five years. Without the software to read the data, it becomes unreadable.
- Prepare external labels which provide a unique identifier for each volume, the name of the organizational unit responsible, and the permanent or archival electronic records title.

Best Practices-Media Preservation and Storage

- Select appropriate storage media and environment.
- Store media in environmentally controlled conditions. Humidity does not exceed 50% and does not fall below 30%. Room temperature is stable at 65 to 75 degrees Fahrenheit. Adhere to the media manufacturer's vendor's recommendations for specific environmental conditions in which the media should be stored.
- Never operate drive systems in environments with high models of airborne particles.
- If using optical media, periodically clean optical media to remove dust and other particulates.
- To protect disks from warping they should not be subject to pressure and should be stored in an upright position when not in the disk drive.
- For magnetic computer media tapes that contain permanent or archival electronic records, tapes should be rewound under constant tension all tapes and cartridges at least every 2 years; annually test a 3 percent statistical sample of all volumes, or 10 volumes of each type, of magnetic media, whichever is larger, to identify any loss of data and to discover and correct the causes of data loss;
- Labels for media should include the following:
 - Identifiers— including creator, date created, division or agency where created, Name of agency, unit, and division that is responsible for the records on the disk, Hardware, operating system, and software required to access the index or information on the disk, encoding standard and version, model of security or restricted access, sequential number or other specific identifier that identifies the disk in the series of disks used by the system, identification of the disk as master or back-up storage copy, retention dates of the information on the media, data classification: If it is stored off-site, is the data confidential, who can access it, who can read the data, and are there different models of confidentiality, e.g. are parts of the record public records while parts of it are confidential?
- If the disk or other format is too small to include all of the information on the label, then establish a coding system that can be linked back to an index that holds all of the vital

information. Documentation relating to the coding system and index must be maintained for as long as it relates to any labeled storage medium.

Electronic document images are true copies of the documents from which they were made, a **true copy** is defined as being one that accurately reproduces an original document.

Best Practices-Eye to the Future

- Practitioners of a trusted digital repository should take measures to keep abreast of changing industry standards and technologies to ensure the survivability of the system. Practitioners should exercise special care to identify emerging industry standards and develop plans to adopt them.

Best Practices-Legal Admissibility Standards

- *The Uniform Photographic Copies of Business and Public Records as Evidence Act* permits the substitution of photographic copies for original documents for judicial or administrative purposes, provided that the copies are produced in the regular course of business and that no laws or regulations require retention of the original documents. Where these conditions are satisfied, the Uniform Photographic Copies of Business and Public Records as Evidence Act permits, but does not mandate, the destruction of original documents. In the case of North Carolina, however, specific exemptions are made, as follows:
- § G.S. 8-45.1. *Photographic reproductions admissible; destruction of originals.*
 - (a) If any business, institution, member of a profession or calling, or any department or agency of government, in the regular course of business or activity has kept or recorded any memorandum, writing, entry, print, representation, X ray or combination thereof, of any act, transaction, occurrence or event, and in the regular course of business has caused any or all of the same to be recorded, copied or reproduced by any photographic, photostatic, microfilm, microcard, miniature photographic, or other process which accurately reproduces or forms a durable medium for so reproducing the original, the original may be destroyed in the regular course of business unless held in a custodial or fiduciary capacity or unless its preservation is required by law. Such reproduction, when satisfactorily identified, is as admissible in evidence as the original itself in any judicial or administrative proceeding whether the original is in existence or not and an enlargement or facsimile of such reproduction is likewise admissible in evidence if the original reproduction is in existence and available for inspection under direction of court. The introduction of a reproduced record, enlargement or facsimile, does not preclude admission of the original.
 - (b) The provisions of subsection (a) of this section shall apply to records stored on any form of permanent, computer-readable media, such as a CD-ROM, if the medium is not subject to erasure or alteration. Nonerasable, computer-readable storage media shall not be used for preservation duplicates, as defined in G.S. 132-8.2, or for the preservation of permanently valuable records as provided in G.S. 121-5(d), except to the extent expressly approved by the Department of Cultural Resources pursuant to

standards and conditions established by the Department. (1951, ch. 262, s. 1; 1977, ch. 569; 1999-131, s. 1; 1999-456, s. 47(a).)

- § G.S. 153A-436. *Photographic reproduction of county records.*
 - (a) A county may provide for the reproduction, by photocopy, photograph, microphotograph, or any other method of reproduction that gives legible and permanent copies, of instruments, documents, and other papers filed with the register of deeds and of any other county records. The county shall keep each reproduction of an instrument, document, paper, or other record in a fire-resistant file, vault, or similar container. If a duplicate reproduction is made to provide a security-copy, the county shall keep the duplicate in a fire-resistant file, vault, or similar container separate from that housing the principal reproduction.

If a county has provided for reproducing records, any custodian of public records of the county may cause to be reproduced any of the records under, or coming under, his custody.
 - (b) If a county has provided for reproducing some or all county records, the custodian of any instrument, document, paper, or other record may permit it to be removed from its regular repository for up to 24 hours in order to be reproduced. An instrument, document, paper or other record may be removed from the county in order to be reproduced. The board of commissioners may permit an instrument, document, paper, or other record to be removed for longer than 24 hours if a longer period is necessary to complete the process of reproduction.
 - (c) The original of any instrument, document, or other paper received by the register of deeds and reproduced pursuant to this Article shall be filed, maintained, and disposed of in accordance with G.S. 161-17 and G.S. 121-5. The original of any other county record that is reproduced pursuant to this Article may be kept by the county or disposed of pursuant to G.S. 121-5.
 - (d) If an instrument, document, or other paper received by the register of deeds is reproduced pursuant to this Article, the recording of the reproduction is a sufficient recording for all purposes.
 - (e) A reproduction, made pursuant to this Article, of an instrument, document, paper, or other record is as admissible in evidence in any judicial or administrative proceeding as the original itself, whether the original is extant or not. An enlargement or other facsimile of the reproduction is also admissible in evidence if the original reproduction is extant and available for inspection under the direction of the court or administrative agency.
 - (f) The provisions of this section shall apply to records stored on any form of permanent, computer-readable media, such as a CD-ROM, if the medium is not subject to erasure or alteration. Nonerasable, computer-readable storage media shall not be used for preservation duplicates, as defined in G.S. 132-8.2, or for the preservation of permanently valuable records as provided in G.S. 121-5(d), except to the extent expressly approved by the Department of Cultural Resources pursuant to standards and conditions established by the Department. (1945, c. 286, ss. 1-7; c. 944; 1951, c. 19, ss. 1-6; 1953, c. 675, ss. 23, 24; 1957, c. 330, s. 3; 1973, c. 822, s. 1; 1999-131, s. 4; 1999-456, s. 47(d).)
- *Rule 1003 of the Uniform Rules of Evidence and Federal Rules of Evidence* provides for admission of duplicate records in evidence unless serious questions are raised about the authenticity of original records from which the copies were made or, in specific

circumstances, admitting a copy in lieu of an original is judged unfair. Rule 1003 does not require that duplicate records be produced in the regular course of business. It does not authorize or prohibit destruction of original records.

Sources

Center for International Earth Science Information Network (CIESIN), Guide to Managing Geospatial Electronic Records. Columbia University, 2005.

Natoli, James G., New York State Office for Technology. "Governor's Task Force on Information Resource Management, Technology Policy 96-10" www.oft.state.ny.us/policy/tp_9610.htm, 1996.

Consultative Committee for Space Data Systems (CCSDS), Reference Model for an Open Archival Information System (OAIS), CCSDS 650.0-B-1 Blue Book, January 2002.

Rothenberg, Jeffrey, Avoiding Technological Quicksand: Finding a Viable Technical Foundation for Digital Preservation. Council on Library and Information Resources: Commission on Preservation and Access Digital Libraries, 1998.

North Carolina Exploring Cultural Resources, NC ECHO Dublin Core Implementation Guidelines , Raleigh, North Carolina, April 24, 2004.

ADDENDUM F

Security Backup Files *as* ***Public Records In North Carolina: Guidelines for the Recycling, Destruction, Erasure, and Re-use of Security Backup Files***

Department of Cultural Resources
N.C. Division of Historical Resources
Archives and Records Section/Government Records Branch

Purpose: To establish requirements under G.S. § 132-3 for permitting the recycling, destruction, erasure, and re-use of security backup/data backup files and their media.

Policy: Security backup files are public records (according to G.S. §§ 121-2(8) and 132-1) and may not be disposed of, erased, or destroyed (according to G.S. § 132-3) without specific guidance from the Department of Cultural Resources.

These guidelines provide that guidance and permit the recycling, destruction, erasure, and re-use of security backup files and their media when an agency has implemented a written security backup plan and process that:

- Documents the procedures that are employed for each records series appropriate to that series' organizational value and vulnerability.
- Provides the minimum acceptable capability for recovery of each records series.
- Provides for the periodic verification that files and/or systems can be restored from the backup media as appropriate.

Rationale for an Effective Security Backup Policy

Electronic data and information are assets. Security backups are critical to the survival of electronic data. Human or natural disasters, accidents involving the handling of media, and human error make electronic media vulnerable to damage.

“Versioning” and “Archiving” do not create security backup files. Versioning intentionally maintains copies of data files as the files are changed. Each version becomes a distinct record. Archiving is the process of moving a record from one medium (usually quickly accessible, but fragile) to another (usually more permanent) medium.

When meticulously planned and properly implemented, security backups make possible the retrieval of lost data and the resumption of system operations. Such procedures are a critical part of computer operations at all models, especially those involving the storage of long-term or permanent records on electronic media. Security backups may also be critical to the fulfillment of audit requirements and the maintenance of audit trails in fiscal systems. For many applications, multiple copies and/or generations of backups may be recommended.

Planning and implementing security backups require consideration of several points:

Security backup files are not used as most records are. Backup files are created to protect against data loss. Backup files are typically created according to a schedule or policy; they are created, retained, and then destroyed. Security backup files provide the comfort of being able to, for a limited time, reverse an action that would normally result in the loss of a record. Backup files are created and maintained by the agency creating the original records, or by a separate agency or unit (LAN administration, information technology unit etc.) performing this service.

Security backup files are records but should always be associated with the records they serve to protect. Since electronic records must be indexed or otherwise made accessible for official use, security backup files will not normally be used to meet records retention requirements. Security backup files are generated expressly for the purpose of restoring computer systems in the event of a disaster or accidental damage. The content of security backup files may not be indexed and may not reflect the order, arrangement, or structure of the original data.

Security backup files will be found everywhere. Whether done by the originating office or by a separate unit, security backup files should be generated for all but the most transitory of records. **Agencies are required by the Information Resource Management Commission (IRMC) to keep track of all information assets and to document the controls they have in place for safeguarding those assets.** (IRMC, "Information Asset Protection Policy", approved 5/5/98, revised 11/6/01,

<http://irmc.state.nc.us/documents/approvals/InformationAssetProtection.pdf>).

Three factors determine the quality of a backup policy. There are three attributes that can be used to measure the quality of any system used to create and keep security backup files.

1. Persistence. This measures how well media are able to store data reliably. Every medium has an error rate; the lower this rate, the better the medium. This base-line persistence can be enhanced by creating more than one copy, keeping copies off-site or at multiple locations, media rotation, and controlling the environmental conditions.
2. Granularity. Granularity is the frequency with which backup files are made. A system in which backup files are created daily is more current than one in which backups are made weekly.
3. Duration. This is the length of time backup files are kept: specifically, the length of time after a change is made that allows that change to be reversed.

Backup policy specifications should be recorded in two ways.

1. Agencies should document the backup policies they employ or have employed for them, within the rubric of their asset protection documentation. Agencies often employ only a small number of distinct backup policies. Some record series are very important and receive the best care, while other record series are less important and receive less care. Once a policy is established for one record series, it is often applied identically to other records with similar value. Therefore, the most efficient way to document each record series backup policy is first to describe each distinct policy and then to identify to which record series the policy applies. This kind of documentation should be a part of your agency's asset protection strategy and should be written down.

2. Each agency should establish the minimum acceptable capability for recovery that must be provided for each record series. Some record series may not warrant an explicit declaration of backup policy requirements. Agencies are, however, required to take proper care of those records that are necessary to the agency's day-to-day operations. For records that have archival, legal, fiscal, or other value that also requires longevity past the duration of the agency's normal use, the duration of the backup copies and the granularity with which they are created should reflect the requirements of those values. A system for maintaining security backup files and their associated procedures must be continued for as long as the approved retention period of the original records and data requires. Retention of security backup files for longer than the retention period specified for the original records and data may subject the agency to unnecessary risks.

For more important record series, the agency should establish specifications regarding how often copies are carried off-site, when duplicate copies must be made on-site, the type of media to use, and what provisions are in place to verify that files or entire systems can be restored from the backup media. For record series that are stored only electronically and especially for those with enduring archival, legal, fiscal, or other value, then more thorough documentation may be required in addition to the types of specifications already noted. Backup documentation should cover, among others, the elements of granularity and frequency, duplication (if applicable) and frequency, and offsite storage and frequency (how often copies---either duplicate or original security backup files---are carried offsite).

ADDENDUM G

Acronyms Used In This Document

ACH	Automated Clearing House
CRC	Cyclical Redundancy Checksum
DOD 5015.2 STD	Department of Defense directive
DTD	Document Type Definition (see Glossary)
E-SIGN	Electronic Signatures in Global & National Commerce
FTP	File Transfer Protocol
HTML	HyperText Markup Language
HTTP	HyperText Transfer Protocol
HTTPS	HyperText Transfer Protocol Secure
IS	Information Services
IT	Information Technology
MISMO	Mortgage Industry Standards Maintenance Organization
MOU	Memorandum of Understanding
NCCUSL	National Conference of Commissioners on Uniform State Laws
NCERC	North Carolina Electronic Recording Council
OAIS	Open Archival Information Systems
PDF	Portable Document Format
PKI	Public Key Infrastructure (see Glossary)

PRIA	Property Records Industry Association
SGML	Standard Generalized Markup Language
SLA	Service Level Agreements
SSL	Secure Socket Layer (see Glossary)
TIFF	Tagged Information File Format (see Glossary)
UETA	Uniform Electronic Transaction Act
URPERA	Uniform Real Property Electronic Recording Act
VPN	Virtual Private Network
XHTML	Extensible Hyper Text Markup Language
XML	Extensible Markup Language (see Glossary)

ADDENDUM H

**GENERAL ASSEMBLY OF NORTH CAROLINA
SESSION 2005**

**SESSION LAW 2005-391
SENATE BILL 671**

AN ACT TO ENACT THE UNIFORM REAL PROPERTY ELECTRONIC RECORDING ACT, AS RECOMMENDED BY THE GENERAL STATUTES COMMISSION, TO REPEAL CHAPTER 10A OF THE GENERAL STATUTES REGARDING THE REGULATION OF NOTARIES PUBLIC, AND TO ENACT CHAPTER 10B RELATING TO NOTARIES.

The General Assembly of North Carolina enacts:

SECTION 1. Chapter 47 of the General Statutes is amended by adding a new Article to read:

"Article 1A.

"Uniform Real Property Electronic Recording Act.

"§ 47-16.1. Short title.

This Article may be cited as the Uniform Real Property Electronic Recording Act.

"§ 47-16.2. Definitions.

In this Article:

- (1) "Document" means information that is:
 - a. Inscribed on a tangible medium or that is stored in an electronic or other medium and is retrievable in perceivable form; and
 - b. Eligible to be recorded in the land records maintained by the register of deeds.
- (2) "Electronic" means relating to technology having electrical, digital, magnetic, wireless, optical, electromagnetic, or similar capabilities.
- (3) "Electronic document" means a document that is received by the register of deeds in an electronic form.
- (4) "Electronic signature" means an electronic sound, symbol, or process attached to or logically associated with a document and executed or adopted by a person with the intent to sign the document.

- (5) "Person" means an individual, corporation, business trust, estate, trust, partnership, limited liability company, association, joint venture, public corporation, government, or governmental subdivision, agency, or instrumentality, or any other legal or commercial entity.

"§ 47-16.3. Validity of electronic documents.

(a) If a law requires, as a condition for recording, that a document be an original, be on paper or another tangible medium, or be in writing, the requirement is satisfied by an electronic document satisfying this Article.

(b) If a law requires, as a condition for recording, that a document be signed, the requirement is satisfied by an electronic signature.

(c) A requirement that a document or a signature associated with a document be notarized, acknowledged, verified, witnessed, or made under oath is satisfied if the electronic signature of the person authorized to notarize, acknowledge, verify, witness, or administer the oath, and all other information required to be included, is attached to or logically associated with the document or signature. A physical or electronic image of a stamp, impression, or seal need not accompany an electronic signature. Nothing in this act shall prohibit the North Carolina Board of Examiners for Engineers and Surveyors from requiring that the image of a seal accompany any plat or map that is presented electronically for recording.

"§ 47-16.4. Recording of documents.

(a) In this section, "paper document" means a document that is received by the register of deeds in a form that is not electronic.

(b) A register of deeds:

- (1) Who implements any of the functions listed in this section shall do so in compliance with standards adopted by the Secretary of State.
- (2) May receive, index, store, archive, and transmit electronic documents.
- (3) May provide for access to, and for search and retrieval of, documents and information by electronic means.
- (4) Who accepts electronic documents for recording shall continue to accept paper documents as authorized by law and shall place entries for both types of documents in the same index.
- (5) May convert paper documents accepted for recording into electronic form.
- (6) May convert into electronic form information recorded before the register of deeds began to record electronic documents.
- (7) May accept electronically any fee or tax that the register of deeds is authorized to collect.

- (8) May agree with other officials of this State or a political subdivision thereof on procedures or processes to facilitate the electronic satisfaction of conditions to recording and the electronic payment of fees and taxes.

"§ 47-16.5. Administration and standards.

(a) Standard-Setting Agency. – The Secretary of State shall adopt standards to implement this Article upon recommendation of the Electronic Recording Council. The Secretary of State may direct the Council to revise any portion of the recommended standards the Secretary deems inadequate or inappropriate. Technological standards and specifications adopted by the Secretary of State to implement this Article are engineering standards for the purposes of G.S. 150B-2(8a)h.

(b) Electronic Recording Council Created. – The Electronic Recording Council is created in the Department of the Secretary of State to advise and assist the Secretary of State in the adoption of standards to implement this Article. The Council shall review the functions listed in G.S. 47-16.4 and shall formulate and recommend to the Secretary standards for recording electronic documents and implementing the other functions listed in G.S. 47-16.4. The Council shall report its findings and recommendations to the Secretary of State at least once each calendar year. The Council shall advise the Secretary of State on a continuing basis of the need to adopt, amend, revise, or repeal standards. The Council may advise the Secretary of State on any other matter the Secretary refers to the Council.

(c) Council Membership, Terms, and Vacancies. – The Council shall consist of 13 members as follows:

- (1) Seven members appointed by the North Carolina Association of Registers of Deeds. It is the intent of the General Assembly that the North Carolina Association of Registers of Deeds shall appoint as members a representative selection of registers of deeds from large, medium, and small counties, urban and rural counties, and the different geographic areas of this State.
- (2) One member appointed by the North Carolina Bar Association.
- (3) One member appointed by the North Carolina Society of Land Surveyors.
- (4) One member appointed by the North Carolina Bankers Association.
- (5) One member appointed by the North Carolina Land Title Association.
- (6) One member appointed by the North Carolina Association of Assessing Officers.
- (7) The Secretary of Cultural Resources or the Secretary's designee.

In making appointments to the Council, each appointing authority shall select appointees with the ability and commitment to fulfill the purposes of the Council.

Appointed members shall serve four-year terms, except that the initial appointments by the North Carolina Bar Association, the North Carolina Bankers Association, the North Carolina Association of Assessing Officers, and three of the initial appointments by the North Carolina Association of Registers of Deeds shall be for two years. All initial terms shall commence on the effective date of this Article. Members shall serve until their successors are appointed. An appointing authority may reappoint a member for successive terms. A vacancy on the Council shall be filled in the same manner in which the original appointment was made, and the term shall be for the balance of the unexpired term.

(d) Council Meetings and Officers. – The Secretary of State shall call the first meeting of the Council. At the first meeting and biennially thereafter, the Council shall elect from its membership a chair and a vice-chair to serve two-year terms. Meetings may be called by the chair, the vice-chair, or the Secretary of State. Meetings shall be held as often as necessary, but at least once a year.

(e) Council Compensation. – None of the members of the Council shall receive compensation for serving on the Council, but Council members shall receive per diem, subsistence, and travel expenses in accordance with G.S. 138-5 and G.S. 138-6, as applicable.

(f) Staff and Other Assistance. – As soon as practicable and as needed thereafter, the Council shall identify the information technology expertise it needs and report its needs to the Secretary of State. The Council shall also report any other expertise needed to fulfill its responsibilities. The Secretary of State shall provide professional and clerical staff and other services and supplies, including meeting space, as needed for the Council to carry out its duties in an effective manner. The Secretary of State may appoint additional committees to advise and assist the Council in its work.

The Council shall consult with the North Carolina Local Government Information Systems Association, and may consult with any other person the Council deems appropriate, to advise and assist the Council in its work.

(g) Uniformity of Standards. – To keep the standards and practices of registers of deeds in this State in harmony with the standards and practices of recording offices in other jurisdictions that enact substantially this Article and to keep the technology used by registers of deeds in this State compatible with technology used by recording offices in other jurisdictions that enact substantially this Article, the Secretary of State and the Council shall consider all of the following in carrying out their responsibilities under this Article, so far as is consistent with its purposes, policies, and provisions:

- (1) Standards and practices of other jurisdictions.
- (2) The most recent standards adopted by national standard-setting bodies, such as the Property Records Industry Association.

- (3) The views of interested persons and other governmental officials and entities.
- (4) The needs of counties of varying size, population, and resources.
- (5) Standards requiring adequate information security protection to ensure that electronic documents are accurate, authentic, adequately preserved, and resistant to tampering.

"§ 47-16.6. Uniformity of application and construction.

In applying and construing this Article, consideration shall be given to promoting uniformity of interpretation of the Uniform Real Property Electronic Recording Act among states that enact it.

"§ 47 -16.7. Relation to Electronic Signatures in Global and National Commerce Act.

This Article modifies, limits, and supersedes the federal Electronic Signatures in Global and National Commerce Act (15 U.S.C. § 7001, et seq.) but does not modify, limit, or supersede section 101(c) of that act (15 U.S.C. § 7001(c)) or authorize electronic delivery of any of the notices described in section 103(b) of that act (15 U.S.C. § 7003(b))."

SECTION 2. The Revisor of Statutes shall cause to be printed along with this act all relevant portions of the official comments to the Uniform Real Property Electronic Recording Act and all explanatory comments of the drafters of this act as the Revisor deems appropriate.

ADDENDUM I

G. S. §47-14 As Amended By Session Law 2008-194

§ 47 -14. Register of deeds to verify the presence of proof or acknowledgement and register instruments; instruments and electronic documents; order by judge; instruments to which register of deeds is a party.

(a) Verification of Instruments. – The register of deeds shall not accept for registration any instrument that requires proof or acknowledgement unless the execution of the instrument by one or more signers appears to have been proved or acknowledged before an officer with the apparent authority to take proofs or acknowledgements, and the ~~said~~ proof or acknowledgement includes the officer's signature, commission expiration date, and official seal, if required. The register of deeds shall accept an instrument for registration that does not require proof or acknowledgement if the instrument otherwise satisfies the requirements of G.S. 161-14. Any ~~document-instrument~~ previously recorded or any certified copy of any ~~document-instrument~~ previously recorded may be rerecorded, regardless of whether it has been changed or altered, or it is being rerecorded pursuant to ~~G.S. 47-36.1. rerecorded provided the instrument is conspicuously marked on the first page as a rerecording.~~ The register of deeds may rely on the marking and the appearance of the original recording office's recording information to determine that an instrument is being presented as it was previously recorded. The register of deeds is not required to further verify the proof or acknowledgement of or determine whether any changes or alterations have been made after the original recording to an instrument presented for rerecording. The register of deeds shall not be is not required to verify or make inquiry concerning any of the following:

- (1) ~~(i) the~~ The legal sufficiency of any proof or acknowledgement, acknowledgement.
- (2) ~~(ii) the~~ The authority of any officer who took a proof or acknowledgement, acknowledgement.
- (3) ~~(iii) the~~ The legal sufficiency of any document presented for registration, registration, or (iv) upon presentation of the original document for re-recording, whether the original document has been changed or altered."

(a1) Verification of Electronic Documents. – The requirements of subsection (a) of this section for verification of the execution of an instrument are satisfied with respect to an electronic document if all of the conditions in this subsection are met. For purposes of this subsection, the term "electronic document" is as defined in G.S. 47-16.2(3). The conditions are:

- (1) The register of deeds has authorized the submitter to electronically register the electronic document.
- (2) The document is submitted by a United States federal or state governmental unit or instrumentality or a trusted submitter. For purposes of this subsection, "a trusted submitter" means a person or entity that has entered into a memorandum of understanding regarding electronic recording with the register of deeds in the county in which the electronic document is to be submitted.
- (3) The execution of the instrument by one or more signers appears to have been proved or acknowledged before an officer with the apparent authority to take proofs or acknowledgements, and the proof or acknowledgment includes the officer's signature, commission expiration date, and official seal, if required, based on the appearance of these elements on the digitized image of the document as it will appear on the public record.
- (4) Evidence of other required governmental certification or annotation appears on the digitized image of the document as it will appear on the public record.
- (5) With respect to a document submitted by a trusted submitter, the digitized image of the document as it will appear on the public record contains the submitter's name in the following completed statement on the first page of the document image: "Submitted electronically by _____ (submitter's name) in compliance with North Carolina statutes governing recordable documents and the terms of the submitter agreement with the _____ (insert county name) County Register of Deeds."
- (6) Except as otherwise provided in this subsection, the digitized image of the electronic document conforms to all other applicable laws and rules that prescribe recordation.

(a2) Verification of Officer's Signature. – Submission to a register of deeds of an electronic document requiring proof or acknowledgement is a representation by the submitter that, prior to submission, the submitter verified the officer's signature required under subdivision (a1)(3) of this section to be one of the types of signatures listed in this subsection. The register of deeds may rely on this representation for purposes of determining compliance with the signature requirements of this section. The electronic registration of a document with a register of deeds prior to the effective date of this statute is not invalid based on whether the register verified the officer's signature in accordance with this subsection. The types of signatures are:

- (1) A signature in ink by hand.
- (2) An electronic signature as defined in G.S. 10B-101(7).

(b) Order by Judge. – If a register of deeds denies registration pursuant to subsection (a), the person offering the instrument for registration may ~~present the instrument~~ apply to any judge of the district court in the district, including the county in which the instrument is to be registered, for an order for registration a judge, as provided in subsection (c), and the Upon finding all of the requirements in this subsection, the judge shall determine that if ~~order the instrument to be registered, together with the certificates, and the register of deeds shall register them accordingly.~~ The requirements are:

(1) If the instrument requires proof or acknowledgment and if acknowledgment, that the signature of one or more signers has been proved or acknowledged before an officer authorized to take proofs and acknowledgements, and if ~~said acknowledgements.~~

(2) That the proof or acknowledgment includes the officer's signature and commission expiration date and official seal, if required. ~~required, the judge shall so adjudge, and shall order the instrument to be registered, together with the certificates, and the register of deeds shall register them accordingly.~~

(c) ~~Application for an order for registration pursuant to subsection (b) of this section shall be made to any judge of the district court in the district including the county in which the instrument is to be registered.~~

(d) Scope. – Registration of an instrument pursuant to this section is not effective with regard to parties who have not executed the instrument or whose execution thereof has not been duly proved or acknowledged.

(e) Register of Deeds as Party. – Any instrument required or permitted by law to be registered in which the register of deeds of the county of registration is a party may be proved or acknowledged before any magistrate or any notary public. ~~Any such~~ The clerk of superior court of the county of registration shall examine any instrument presented for registration. ~~registration shall be examined by the clerk of superior court of the county of registration and if~~ If it appears that the execution and acknowledgment are in due form ~~he form, the clerk shall so certify and the instrument shall then be recorded in the office of the register of deeds.~~

(f) Presumption of Notarial Seal. – The acceptance of a record for registration by the register of deeds shall give rise to a presumption that, at the time the record was presented for registration, a clear and legible image of the notary's official seal was affixed or embossed on the record near the notary's official signature. This presumption ~~shall apply~~ applies regardless of whether the image is legible or photographically reproduced in the records maintained by the register of deeds. A register of deeds may not refuse to accept a record for registration because a notarial seal does not satisfy the requirements of G.S. 10B-37."

ADDENDUM J

Statutes Affected by e-recording or e-notary

Statutes affected by e-recording or e-notary (Ferguson, 1-23-05)
Edited for E-Recording Council (Shaw, 8-9-06)

- NOTE #1: ANY REFERENCE IN ANY STATUTE TO CHAPTER 10A WOULD NEED CORRECTION TO ASSURE THE REFERENCE WAS TO THE APPROPRIATE NEW SECTION.
- NOTE #2: OTHER STATE AGENCIES HAVE FORMS WHICH ARE ADMINISTRATIVE, BUT NOT STATUTORY, LIKE AOC, DEHNR, DMV, DOT, ETC.
- NOTE #3: "STANDARDS" AND "CODING" WILL BE SIGNIFICANTLY AFFECTED BY WHAT THE REGISTER OF DEEDS HAS TO VERIFY TO RECORD (FROM PIN# TO ALL "PARTIES" TO PRIOR BOOKS/PAGES) RATHER THAN REGISTERS SERVING AS JUST REGISTERS.
- NOTE #4: OUTSIDE "PAPER" REQUIREMENTS (SUCH A SURVEYOR'S SEAL, LARGE FORMATTING, ETC.) APPLICABLE TO MAPS & PLATS NEED TO BE RESOLVED IN MANY STATUTES.
- NOTE #5: "SUBSEQUENT RECORDING" ISSUES NEED TO BE ADDRESSED BETTER THROUGH INDEXING & FOR STANDARDS / CODING -- SUCH AS CANCELLATIONS, ASSIGNMENTS, CORRECTIONS
- NOTE #6: MINIMUM STANDARDS OF INDEXING REAL PROPERTY INSTRUMENTS NEED UPGRADING TO ELECTRONIC INDEXING & MODERN DEMOGRAPHIC ISSUES.
- **Note #7: SL 2006-59, SECTION 32: "The General Statutes Commission shall study the need for additional changes to laws relating to notaries public, the notarization of documents, and the registration of instruments notarized in other jurisdictions. The Commission shall determine whether there is a need for additional conforming changes in the law that arise from changes made by this act and recommend to the General Assembly any legislation to address the needs identified by this study. The General Statutes Commission shall report the results of its study to either the 2007 or 2009 General Assembly." This study commission could have a dramatic impact on status of many of statutes listed below.**

Statutes Table

Statute	Topic	Form	Comment	Status - 2006
1C-1604	Exemption Orders		No notarization	
10A	Notary statute	yes	In process - Advisory Council on e-recording; Secretary of State on "paper" notary	Replaced by 10B
10A-9(e)	Military acknowledgments		Subject to federal law	10A-9(e)
22A-1	Signature of handicapped person	no	Sig by Mark in 10A-31 - stands alone	
31B-1	Renunciations	no	Being revised by GSC --- General Ack	
31B-1	Renunciations	no	Being revised by GSC --- General Ack	
31-11.6	Self-proving will	yes	Should remain specific	
32A-1	Power of Attorney	yes	Should remain specific	
32A-25	Health Care Power of Attorney	yes	Should remain specific	
32A-34	Health Care authorization for minor	yes	Amend / Replace w/ Gen Ack	
33B-18	Custodial trust	yes	Amend / Replace w/ Gen Ack	
40A-43 & 40A-51	Condemnation - Memorandum of Action		General Ack	
43	Torrens		Specific requirements for actual Certificate for transfer or voluntary lien, rather than just recording "new" instrument.	
44A-12	Claim of Lien	yes	No notary form	
44A-12.1	Fraudulent claim of lien	no	No notary form	
Ch. 45	Deeds of Trust & Mortgages		General Ack	
45-21.17	Foreclosures		No notarization	
45-21.17A	Request for copy of notice of sale	yes	General Ack	
45-37 & 45-37.2	DOT cancellations		Current revisions / simplification draft in process by RPS and NC Bankers in response to Uniform Mortgage	

North Carolina Electronic Recording Council
10/20/11

Statute	Topic	Form	Comment	Status - 2006
			Satisfaction Act --- General Ack	
33B-18	Custodial trust	yes	Amend / Replace w/ Gen Ack	
40A-43 & 40A-51	Condemnation - Memorandum of Action		General Ack	
43	Torrens		Specific requirements for actual Certificate for transfer or voluntary lien, rather than just recording "new" instrument.	
44A-12	Claim of Lien	yes	No notary form	
44A-12.1	Fraudulent claim of lien	no	No notary form	
Ch. 45	Deeds of Trust & Mortgages		General Ack	
45-21.17	Foreclosures		No notarization	
45-21.17A	Request for copy of notice of sale	yes	General Ack	
45-37 & 45- 37.2	DOT cancellations		Current revisions / simplification draft in process by RPS and NC Bankers in response to Uniform Mortgage Satisfaction Act --- General Ack	
45-42	Corporate satisfaction	no	General Ack	
45-72	Future advance DOT termination	yes	Current revisions / simplification draft in process by RPS and NC Bankers in response to Uniform Mortgage Satisfaction Act --- General Ack	
45-82.1	Extension of equity line of credit DOT	yes	Current revisions / simplification draft in process by RPS and NC Bankers in response to Uniform Mortgage Satisfaction Act --- General Ack	
Chap 45A	Good Funds Settlement Act		affects residential property transfers; 45A- 4 outlines payment methods; definitions	
46-18	Partition -- map		See Note #4 above -no notarization	

North Carolina Electronic Recording Council
10/20/11

Statute	Topic	Form	Comment	Status - 2006
46-20	Partition -- Report and confirmation enrolled & registered		No notarization	
Ch. 47				
47-2	Fed/Foreign officials acknowledging	no	Why should FFC not govern?	
47-2.2	foreign notaries - no seal or expiration	no		
47-5	Seal	no		
47-12 & 12.1	Subscribing witness	yes		
47-13 & -13.1	Unattested document	no		
47-14	Notary acknowledgment certification by ROD for both recording and re-recording.	Endorsement Statement	Re-Draft under Session Law 2008-194	10-01-08
47-16	Corporate deeds, corporation ceased to exist	no	More in nature of 10-year Statute of Limitation	
47-17	Probate & registration without livery of seizin.	no		
47-17.1	Draftsman designation	no	?? Should not be Precondition to recording?? Standards and coding issue	Recording issue
47-17.2	Assignments	no	Subsequent recording issue	
47-18	Deeds, contracts, leases, options -- priority based on recordation	no	Under techn. Amdt by Gen.Stat.Commission	
47-18.1	Entity mergers, amendments & conversions - SOS certificate	no	Certificate by SOS	
47-18.2	Inheritance and Estate Tax Waiver from Secr. Of Revenue	no	Certificate by Department of Revenue	
47-18.3	Corporate officers	no	Standards and coding	

North Carolina Electronic Recording Council
10/20/11

Statute	Topic	Form	Comment	Status - 2006
	executing documents		issue - Ferguson ask Business Law Sec.	
47-19	Unregistered deeds pre-1/20 - affidavit	no	Also an Indexing General Statute	
47-20	Deeds of trust -- priority based on recordation	no	Under techn. Amdt by Gen.Stat.Commission	
47-20.3	Pers & Real Property - Records f/ type/property involved		Interaction of Revised Article 9.	
47-20.5	After Acquired Property	no	Subsequent recording issue	
47-20.6	Mobile Home - DMV title	no	DMV administrative form	
47-20.7	Mobile Home - no DMV title	no		
47-21	Master Deed of trust	no	Subsequent recording issue	
47-25	Marriage settlements	no		
47-27	Deeds of Easement		Attach notice probated copy?	
47-28	Power of attorney - notarizing AIF signature	no	Needs clarification - Chapter 32A; Ferguson ask Estate Planning Section	
47-29	Bankruptcy records	no	Certificate from Bankruptcy Court	
47-29.1	Environmental notices (SEE LIST IN STATUTE)	no	(See specific statutes referenced)	
47-30, 47-30.1, 47-32 & 47-32.1	Maps, plats and surveys	yes	Map and Plat issues (Board of Engineers)	
47-31, -33 & -34	Certified copies	Endorsement Statement	See re-draft under Session Law 2008-194. Keeper's certificate and submitter's endorsement	10-01-08
47-36	Court ordered correction	no		

47-36.1	Correction of errors -- Explanation statement	Endorsement Statement	Re-draft of Session Law 2008-194 addresses re-recording and only allows for corrections to previously recorded documents by either (1) rerecording with new signature with new acknowledgment; (2) rerecording original document with the notation of "RERECORDED" on face of unaltered document; or (3) recording scrivener's affidavit with or without attachments. Electronically transmitted documents must contain submitter's endorsement.	
47-37	Certificate of Register of Deeds	yes	Needs reduction to items verifiable by computer system.	Repealed by SL 2005-123
47-38	Acknowledgment by Grantor	yes	Replace w/10A-27 (?) proposal	
47-40	Husband & wife acknowledgment	yes	Replace w/10A-27 (?) proposal	
47-41.01 & 47-41.02	Corporate acknowledgment	yes	Rewrite of 10A; Ferguson contacting Business Law Section	
47-41.1	Corporate seal	yes	Needs to facilitate e-seal - - What is a "corp seal" in e-world f/descript to apply?	
47-43	Attorney in fact acknowledgment	yes	Replace w/10A; Ferguson contacting Estate Planning Section	
47-43.1	Attorney in fact execution	no	Ferguson contacting Estate Planning Section	
47-43.2, 47-43.3 & 47-43.4	Subscribing witness	yes	Replace w/10A-27 (?) proposal	
47-46	Register of Deeds "verification"	no	Query: How can this work in e-world?	
47-46.1	Notice of Satisfaction	yes	Current revisions / simplification draft in process by RPS and NC Bankers in response to Uniform Mortgage Satisfaction Act	See SL 2005-123
47-46.2	Certificate of Satisfaction	yes	Current revisions / simplification draft in	See SL 2005-123

North Carolina Electronic Recording Council
10/20/11

			process by RPS and NC Bankers in response to Uniform Mortgage Satisfaction Act	
47-46.3	Affidavit of Lost Note	yes	Current revisions / simplification draft in process by RPS and NC Bankers in response to Uniform Mortgage Satisfaction Act	See SL 2005-123
47-111 (47-113.2)	Military discharge	yes	Ann talk to VA --- should have been done w/passage - not forms to do here; probably should have repealed 47-109, 110, 111 and 113 when new 47-113 / 7-113.2 passed.	
47-115	Power of attorney - indexing	no	Standards and coding issue	
47-118	Memorandum of Option to Purchase	yes		
47-119	Memorandum of Lease	yes	Add "[Acknowledgment as required by law]"	
47-120	Memorandum of option or lease	no	references 47-118 & 47-119 above	
47A	Planned Unit Developments			
47B	Marketable Title Act			
47B-4	Preservation of Notice	no	Substantive content only	
47C	Condominiums			
47E	Groundwater contamination			
47F	Planned Community Act			
51-8.2	Marriage license when applicant unable to appear	yes		
52-10.1	Separation Agreements	no		
52-10	Marital Agreements	no		
52B	Antenuptial Agreements			
54B-75	Statement of standing to			

North Carolina Electronic Recording Council
10/20/11

	Commissioner of Banks			
55; 55-2-02	Corporation documents	no	No mention of acknowledgment	
55-43.7	Safe deposit box inventory	no		
55A; 55A-2-02	Nonprofit corporation		No mention of acknowledgment	
55B-4	Professional Corporation Act	no	No mention of acknowledgment	
55D; 55D-10(6) & (7)	Reservation of corporate or entity name	only if by SOS rule-making; not statutory	55D-10(6) . . . The document may but need not contain a seal, attestation, acknowledgment, verification, or proof. (7) If the Secretary of State has prescribed a mandatory form for the document, the document must be in or on the prescribed form.	
57	Limited Liability Companies			
57C-2-21 to 22.1	Limited Liability Company	no		
58-71-155	Bondsman POW with securities	yes		
58-72-50	Official Bonds	no		
58-88-20	Claim to NC Association of Rescue and Emergency Medical Services, Inc.	?		
59; 59-201 to 204; 59-	Partnerships			
65-13	Grave Removals	no	Can use general/w/oath	
66-68	Assumed Name Certificates	no	Ref. 47-41.01 & 47-41.02 leave it	
68-18 & 68-18.1	Strays & Impoundment of Livestock	no	General Ack	
80-15	Timber Dealer Trademarks	no	General Ack	
80-33	Farm Names	no	General Ack	
87-109	Contractors (utility - associations)	no	General Ack	
87-110	Utility owners	no	General Ack	
90-321	Declaration of Desire for Natural	yes	Keep form - leave alone	

North Carolina Electronic Recording Council
10/20/11

	Death; Health Care Power of Attorney			
104 E-10	Radioactive Waste	no	General Ack	
105-303	Tax listing - property transfers	no	?? - N/A; Bd of Co Comr may require review by tax assessor before recording	Recording issue - See also GS 161-31
106, Art. 61, § 735-744	Farmland Preservation Enabling Act; Conservation Easements	no	General Ack	
106-803	Siting swine houses	no	General Ack - Cross Ref 47-41.01	
113A-206	Ridge Law - protected ridges	no	N/A	
113A-212	Ridge Law	no	Map/Plat issue & standards/coding General Ack	
121, Art. 4 -- § 121-41	Preservation / Conservation Easements	no	General Ack	
122C-77	Mental Health Instruction	yes	Leave the same	
130A-301	Permit for disposal of waste on land	no	DEHNR Certification	
130A-301.1	Land clearing and inert debris landfill			
130A-301(f)	Notice of Open Dump		Map/Plat issue; DEHNR Certification	
130A-301.2	Demolition debris disposal		Expired 9/30/03	
130A-310	Waste Disposal			
130A-310.8	Inactive Hazardous Substance or Waste Disposal Site		Map/Plat issue	
130A-310.35	Notice of Brownfields Property			
132-7	Certified copies of public records	no	Any public official who causes a record book to be copied shall attest it and shall certify on oath that it is an accurate copy of the original book. The copy shall then have	

North Carolina Electronic Recording Council
10/20/11

			the force of the original.	
136-104	DOT condemnation - memorandum of action and declaration of taking	no	DOT form; no specs	
143-215.85A	Notice of Oil or Hazardous Substance Discharge Site			
143-215.104M	Notice of Dry-Cleaning Solvent Remediation			
143B-279.10	Notice of Contaminated Site			
143B-279.11	Notice of Residual Petroleum			
153A-241	Closing public roads or easement	no		
160A-400.5	Historic Landmarks	no	Ordinance, not form	
161-9	Register of Deeds seal	no	ink of nonconforming type	
161-14	Register of Deeds		161-14(a) ROD must determine that "all statutory and locally adopted prerequisites for recording have been met" & indexing (temp & permanent) -- QUERY: HOW WILL THIS WORK IN E-WORLD?	
161-10			notary cert 161-10(a)(12) & (17) - ROD dealing with notary commissioning	
161-31	Tax Certification	no	Bd of Co Comr may require proof of payment of taxes before recording	Recording issue - See also GS 105-303
162A	Assessments of Water & Sewer			
162A-6	Water & Sewer System - condemnation / eminent domain	no	Condemnation power by authority approved by Environmental Management Commission	
AOC forms	Typically Oath only -- sworn to and subscribed	yes		

10/20/11 ADDENDUM K

**ELECTRONIC RECORDING
(EXAMPLE OF) SUBMITTER AGREEMENT**

THIS SUBMITTER AGREEMENT, dated _____, is between the Office of the Register of Deeds of _____ County, North Carolina (“**COUNTY**”), and _____ (“**SUBMITTER**”) with _____ offices at _____

_____.
The **SUBMITTER** will be transmitting their documents to the **COUNTY** through _____ (“**VENDOR**”).

COUNTY desires to offer the ability to record real property documents by electronic means and to provide for the receiving and transmitting of those documents electronically as a substitute for conventional paper based documents. This includes the electronically based receipt of confirmation of recording.

The **COUNTY** also desires to assure that transactions are legally valid and enforceable as a result of the use of available electronic technologies, to the mutual benefit of the parties of the transactions.

Documents may be submitted in accordance to **COUNTY** guidelines and will only be processed on those days and hours that the **COUNTY** Recording Office is open to the public for business, Monday through Friday, _____, Eastern Time. Documents will not be processed on **COUNTY** holidays, weekends, etc., or in the event of network or equipment failure.

SUBMITTER acknowledges and agrees that all documents electronically submitted to the **COUNTY** for recording shall only become part of the public record and considered properly recorded after the **COUNTY** accepts, records, and indexes each document in the public record pursuant to N.C.G.S. 161-22.

There will be no added fees or costs of any kind charged by the **COUNTY** for Electronic Recording although **SUBMITTER** will be responsible for the payment of normal recordation fees using a method authorized by the **COUNTY**. **SUBMITTER** is responsible for the costs of any services provided by a third party (**VENDOR**) that enables **SUBMITTER** to file their documents electronically.

SUBMITTER and the **COUNTY** recognize the need to ensure that only original documents bearing signatures that are properly notarized are submitted for electronic recording. The **SUBMITTER** is responsible for complying with the originality

requirements. The **COUNTY** will rely on the **SUBMITTER** representation of compliance with the requirements by having the **SUBMITTER** include the following statement on the first page of any document:

Submitted electronically by (submitter's name) in compliance with North Carolina statutes governing recordable documents and the terms of the Submitter Agreement with the _____ County Register of Deeds. GS 47-14 (a1)(5)

SUBMITTER acknowledges that documents submitted and received electronically shall be considered the "original" record of the transaction in substitution for paper documents. The electronic version of the recorded document and electronic recording data, including endorsement and receipt, will be returned or otherwise made available to the **SUBMITTER** after recordation has been completed by the **COUNTY**. Documents that are rejected will be returned to the **SUBMITTER** in electronic format along with a description of the reason(s) for rejection.

SUBMITTER shall provide a contact through which detected problems or issues can be reported and addressed.

Neither the **COUNTY** nor **SUBMITTER** shall be liable to the other for any special or consequential damages arising from, or as a result of, any delay, omission or error in the transmission or receipt of electronic documents.

The **SUBMITTER** agrees that, unless otherwise specified herein, the provisions of North Carolina's Uniform Electronic Transactions Act (UETA) 66 Article 40, the Uniform Real Property Electronic Recording Act (URPERA), and the electronic recording standards as adopted by the North Carolina Secretary of State shall apply to the electronic transactions covered by this Agreement.

Agreed and Accepted:

(SUBMITTER)

By: _____ (Authorized Signature)

Name _____

Title _____

Date: _____

Administrative Contact Name: _____

Phone Number: _____

E-mail Address: _____

(COUNTY)

Administrative Contact Name: Pre-typed text

Phone Number: Pre-typed text

Fax Number: Pre-typed text

Mailing Address: Pre-typed text

E-mail Address: Pre-typed text.gov

10/20/11 ADDENDUM K

**ELECTRONIC RECORDING
(EXAMPLE OF) VENDOR MEMORANDUM OF UNDERSTANDING**

THIS VENDOR MEMORANDUM OF UNDERSTANDING (hereinafter referred to as MOU) dated _____, is between the office of the Register of Deeds of _____ County, North Carolina (“**COUNTY**”), and _____ (“**VENDOR**”) with offices at _____.

_____ County desires to offer the recording of real property documents by electronic means providing for the receiving and transmitting of documents electronically in substitution for conventional paper based documents and to assure that transactions are not legally invalid or unenforceable as a result of the use of available electronic technologies, to the mutual benefit of the parties of the transactions.

For purposes of this MOU, *Electronic Recording* is defined to be the electronically based submitting of documents from **VENDOR** to **COUNTY** and electronically based receipt of confirmation of recording from **COUNTY** to **VENDOR**.

All parties of the Electronic Recording transaction desire to operate and maintain a secure recording system that minimizes the risk of fraud during the electronic transmission of documents. This MOU outlines the procedures and rules for the trusted relationship between the parties involved in Electronic Recording.

The **VENDOR** shall be responsible for assuring that the electronic version of the recorded document and electronic recording data, including endorsement and receipt, is returned or otherwise made available to the SUBMITTER.

Neither the **COUNTY** nor **VENDOR** shall be liable to the other for any special, incidental, exemplary or consequential damages arising from or as a result of any delay, omission or error in the Electronic Recording transmission or receipt.

Neither party shall be liable for any failure to perform processing of the transactions and documents where such failure results from any act of God or other cause beyond the party's reasonable control including, without limitation, any mechanical, electronic or communications failure which prevents the parties from transmitting or receiving the electronic recording transactions.

Either party may terminate this MOU for cause at any time and without cause by providing 30-days written notice to the other party, requiring the **VENDOR** to notify all **SUBMITTERS**.

There will be no added fees or costs of any kind charged by or to the **COUNTY** for Electronic Recording services provided by the **VENDOR**. **VENDOR** is responsible for the costs of the system or services that provide a submitter the ability to use their services to submit electronic documents to the **COUNTY**.

COUNTY shall test and maintain their Electronic Recording software and hardware required to operate the Electronic Recording system. **COUNTY**, however, shall be held harmless and not liable for any damages resulting from software or equipment failure.

VENDOR shall insure that all security measures and credentials implemented are protected from unauthorized access. **VENDOR** assumes all responsibility for the security and integrity of all documents submitted through **VENDOR** for the purposes of engaging in Electronic Recording

VENDOR must maintain an audit trail of all submission activity. Should a dispute or legal action arise concerning an electronic transaction, the **COUNTY** will be held harmless and not liable for any damages.

VENDOR shall be diligent in ensuring that images are present and applicable indexed data is complete as required by the **COUNTY**.

VENDOR is responsible for supporting any technical issues associated with Electronic Recording. **VENDOR** shall work, in good faith, with the **COUNTY** to resolve issues with the Electronic Recording process.

VENDOR shall provide an effective mechanism to the **COUNTY** through which issues can be reported and addressed. In the event that such an issue is determined to be with the **VENDOR** and their system software, including but not limited to the infrastructure provided, the **VENDOR** shall be responsible for resolving such issues and will enlist the assistance of the **COUNTY** as necessary.

VENDOR is responsible for coordinating all administrative and technical problems through the **SUBMITTER** and/or the **COUNTY**.

VENDOR will maintain a qualified technical staff, responsible for developing, maintaining and enforcing security, technical and administrative procedures of their system.

COUNTY will not incur any liability for the information electronically transmitted by the **VENDOR** through their system to **COUNTY**.

COUNTY will not incur any liability for any breach of security, fraud or deceit as a result of Electronic Recording.

Absent gross negligence or willful misconduct, **VENDOR** agrees to release the **COUNTY** from any liability in connection with the electronic filing and recordation of documents under this Agreement. **VENDOR** understands that there are no warranties, express or implied, in connection with such transactions.

The **COUNTY** and **VENDOR** will attempt, in good faith, to resolve any controversy or claim arising out of or relating to Electronic Recording through either negotiation or mediation prior to initiating litigation.

The **COUNTY** and **VENDOR** acknowledge that the electronic recording process is an emerging technology and that State and National standards will continue to evolve. To further the technology and the Electronic Recording process, all parties agree to meet to discuss modifications and additions to this MOU.

All documents subject to this agreement in the custody of the vendor shall be considered confidential. The vendor is only authorized to release said documents to parties designated by the trusted submitter unless compelled by a court of competent jurisdiction.

ATTACHMENTS

Attachment A defines the technical specifications including models of recording supported, format, and transmission protocols of the electronic records required by **COUNTY**. The **VENDOR** agrees to adhere to the transmission protocol of the **COUNTY** following the specifications outlined. **VENDOR** understands that the specifications may change from time to time. In the event changes to the specifications are required, the **COUNTY** will provide a written notice to the **VENDOR** within a reasonable timeframe.

Attachment B contains the document and indexing specifications for the Electronic Recording program.

Attachment C contains the processing schedules and hours of operation for the Electronic Recording program and contact names for all parties.

Attachment D provides the Agreement to Pay and Fee Schedule.

Attachment E provides map and plat specifications required by the **COUNTY**, including but not limited to size requirements, file format, and submission requirements as they relate to the **COUNTY**'s capabilities to reproduce to scale, and to properly archive this electronically recorded document

Agreed and Accepted:

(VENDOR)

By: _____ (Authorized Signature)

Name _____

Title _____

Date: _____

(COUNTY)

By: _____ (Authorized Signature)

Name _____

Title Register of Deeds _____

Date: _____

Attachment A

Technical Specifications

Electronic Recording is defined based on the level of automation and structure of the transaction. The three models of automation are as follows:

Model 1 SUBMITTERS transmit scanned image copies of ink signed documents to the COUNTY with required submitter endorsement according to G. S. §47-14(a1)(5). The COUNTY completes the recording process in the same way as paper using the imaged copy as the original document. The electronic version of the recorded document is returned electronically to the SUBMITTER along with the electronic recording data.

Model 2 SUBMITTERS transmit scanned images of ink signed documents along with electronic indexing information with required submitter endorsement according to G. S. §47-14(a1)(5) to the COUNTY. The COUNTY performs an examination of the imaged documents and indexing data, and then completes the recording process using the imaged copy and electronic indexing information. The electronic version of the recorded document is returned electronically to the SUBMITTERS along with the electronic recording data.

Model 3 SUBMITTERS transmit documents which have been created, signed and notarized electronically along with the electronic indexing information as well as with required submitter endorsement according to G. S. §47-14(a1)(5). The COUNTY performs an examination of the electronic documents and indexing information as well as with required submitter endorsement according to G. S. §47-14(a1)(5) and then completes the recording process using the electronic documents. The electronic version of the recorded document is returned electronically to the SUBMITTERS along with the electronic recording data.

Application of UETA and URPERA

The parties agree that, unless otherwise specified herein, the provisions of North Carolina's Uniform Electronic Transactions Act (hereafter "UETA") (66 Article 40) and North Carolina's Uniform Real Property Electronic Recording Act, codified at Article 1A in Chapter 47 of the General Statutes, (hereafter "URPERA") shall apply to the automated transactions contemplated by this Agreement.

Format of the transmitted File

PRIA file format standard will be used. At this time, images will be in multi-page Group IV TIFF format. The **VENDOR** can work with the **COUNTY** to provide additional fields (extensions) to the current PRIA standard. All documents shall have a 3" margin on the top of the first page.

VENDOR shall provide a method to verify the size of each instrument presented to the Register of Deeds electronically.

Communications Protocol and Options

TCP/IP, HTTP and HTTPS

Models of Electronic Recording Supported

Model 1 and Model 2 after **COUNTY** approves eligibility, and Model 3.

Attachment B

Indexing Fields for each Document Code

All documents submitted will require the minimum index:

Grantor(s)

Grantee(s)

Owner's Name (if contained on map)

Plat Title Name (if instrument is a map)

Document Type and/or Document Code

Number of Pages

Recording Fee (or \$0.00 if none)

Excise Tax (if required)

Related Reference (original document number, in the case of releases, assignments, amendments).

Legal Description Fields

Subdivision Name (if in a subdivision)

Parcel Number (where required on Deeds)

Grantee's Legal Mailing Address (which includes street or post office box, city, state and zip code, **MUST** be clearly identified on any transfer deed.

Notary Requirements per Document

If a law requires a signature or record to be notarized, acknowledged, verified, or made under oath, the requirement is satisfied if the electronic signature of the person authorized to perform those acts, together with all other information required to be included by other applicable laws, is attached to or logically associated with the signature or record.

Attachment C

Service Offering

Hours of Operation

Documents may be submitted in accordance to COUNTY guidelines and will only be processed on those days and hours that the COUNTY Recording Office is open to the public for business, Monday through Friday, _____, Eastern Time. Documents will not be processed on COUNTY holidays, weekends, etc., or in the event of network or equipment failure.

VENDOR acknowledges that all documents electronically submitted to the COUNTY for recording shall only become part of the public record and considered properly recorded after the COUNTY accepts, records, and indexes each document in the public record pursuant to N.C.G.S. 161-22.

Return To Options

Confirmation of acceptance and recordation will be provided to the **VENDOR** in electronic format after recordation is complete. This confirmation will include the document image and COUNTY indexing and endorsement data, including a receipt for fees paid.

Rejections

Submitted documents that are rejected will be returned to the **VENDOR** in electronic format after rejection, along with a description of the reason(s) for rejection.

Contacts for users

All parties shall provide the **COUNTY** with an Administrative Contact (an individual familiar with the process of executing and filing documents) and a Technical Contact (an individual familiar with the **VENDOR** computing environment and capable of resolving or reporting any technical issues):

VENDOR

Administrative Contact Name: _____

- Phone Number: _____
- Fax Number: _____
- E-mail Address: _____
- Other Contact Number(s): _____

Technical Contact Name: _____

- Phone Number: _____
- Fax Number: _____
- E-mail Address: _____
- Other Contact Number(s): _____

COUNTY

Administrative Contact Name: _____

- Phone Number: _____
- Fax Number: _____
- Mailing Address: _____
- E-mail Address: _____
- Other Contact Number(s): _____

Technical Contact Name: _____

- Phone Number: _____
- Fax Number: : _____
- Mailing Address: _____
- E-mail Address: _____
- Other Contact Number(s): _____

Attachment D

Agreement To Pay and Fee Schedule

Agreement To Pay

VENDOR agrees to pay such filing fees as required by NCGS 161-10 and other applicable statutes, on the same day that the documents are electronically filed. The electronic filing system will advise **VENDOR** of the fees required for recordation.

Fee Schedule

Fees are set by G.S. 161-10 and shall apply to all counties in North Carolina. Pursuant to G. S. 105-228.30, excise stamp tax on conveyances of real estate are \$1.00 on each \$500 or fractional part thereof of the consideration value of the interest or property conveyed.

Payment Options

The vendor and the county will need to agree upon methods of payment for each document presented for recording. Two examples are ACH and escrow accounts.

Attachment E
eRecording of Maps and Plats: Submission Specifications

These specifications provide map and plat specifications required by the COUNTY, including but not limited to size requirements, file format, and submission requirements as they relate to the COUNTY's capabilities to reproduce to scale, and to properly archive this electronically recorded document.

ADDENDUM L

EXAMPLE OF A SERVICE LEVEL AGREEMENT

Purpose

This agreement is between Information Services and (Department).

This document outlines the service level roles, responsibilities, and objectives of Information Services and (Department) in support of (Specific Business Process).

Scope of Services

Information Services supports the day-to-day operations of (Department) through the maintenance and support of (Name) application(s) and (Name) systems(s), which run on (List Hardware).

Service offerings include:

Systems Operations	Access to and operation of a data processing environment for the (Business) applications, including backup and recovery
Backups	Regular application backups
Recovery	All hardware and software problems will be covered by the IS problem management process. Data recovery, when required, will be completed in accordance with City Business Continuity Planning standards.
Infrastructure	Provides connectivity to local and wide-area data communication networks and to the Internet
First Level Application Support	Provides operational support of existing application software, such as troubleshooting and correction of processing problems
Consulting	Provides expertise to consult on capacity and infrastructure needs
Desktop Support	Provides for standard desktop software applications, including installation and support of workstation hardware and software required to perform the job, and provides local and remote access to electronic mail and groupware applications

Performance goals

To be determined

Performance measures

To be determined

Constraints

To be determined

Maintenance schedules

Standard: Noon Sunday to 4 A.M. Monday

Addendum A: TSO availability schedule

(Department) TSO availability schedule							
Application	Monday	Tuesday	Wednesday	Thursday	Friday	Saturday	Sunday

Addendum B: Batch turnaround commitments

(Department) Batch turnaround commitments			
Application	Job ID (JCL Job name)	Maximum wait time	Frequency

Addendum C: Critical report outputs

(Department) Critical report outputs			
Report Name (Business Title)	Job ID (JCL Job name)	Distribution	Frequency
			Ad Hoc
			Ad Hoc
			Daily
			Daily
			Daily
			Weekly
			Monthly
			Quarterly
			Yearly

Addendum D: Critical file transfers

(Department) Critical file transfers			
Filename	For Job ID (JCL Job name)	Target Time Available	Target Time for Transfer

Addendum E: Severity one contact list

Severity one contact list					
Contact Name	Title	Location	Application	Business Hours	After Hours
	Director				
	Manager				
	Key User				
	Support				

ADDENDUM M

N.C. Advisory Council E-notary Report

North Carolina Electronic
Recording Council
10/20/11

June 21, 2006

The Honorable Elaine F. Marshall
North Carolina Department of the
Secretary of State
P.O. Box 29622
Raleigh, NC 27626-0622

**Re: Report of the Secretary of State's Advisory Council
on Electronic Notarization Standards**

Dear Secretary Marshall:

Pursuant to your directive of February 14, 2006, the Advisory Council on Electronic Notarization Standards respectfully provides you with the enclosed Report, unanimously approved by the Council on June 20, 2006. We sincerely appreciate having had this opportunity to work with the Council and your staff, and commend to you the members of the Council who spent many hours researching and deliberating electronic notarization standards for this Report. We also sincerely appreciate the support and hospitality provided by your staff, particularly Ozie Stallworth, Gayle Holder and Patty Holloway.

Please note that the Council recognizes two substantial issues which are not addressed with specific recommendations: The first regards a journal for electronic notarial acts, and is discussed on page 4 of the Report. The second issue concerns a separate oath requirement for persons functioning as "electronic notaries." The Council learned on June 20 of a preliminary indication from the Department of Justice on this topic. With regard to both issues, the Council recognizes that, depending upon how the Department elects to address these issues, you may wish to obtain additional advice from this or a similar Council. Members of the Council expressed a willingness to provide such additional assistance should you request it.

In closing, we hope that the Report will be beneficial to the Department and the public. Please contact us should you have any questions, and we wish you and the Department continued success in your endeavors.

Sincerely,

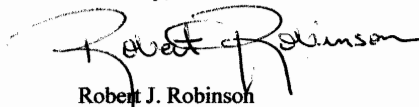

Robert J. Robinson
Co-Chair

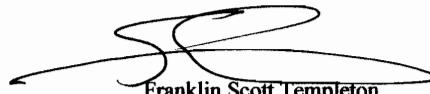

Franklin Scott Templeton
Co-Chair

Enclosure

cc: Advisory Council Members

The Secretary of State's Advisory Council On Electronic Notarization Standards

Final Report – June 20, 2006

On February 14th, 2006, North Carolina Secretary of State Elaine F. Marshall, by directive 1-04, created the Secretary of State's Advisory Council on Electronic Notary Standards. Secretary Marshall charged the Council to "Advise and assist with the creation of rules, standards, procedures, practices, forms and records concerning electronic notarization." The Council met in open sessions over five months; it sought and received professional perspectives from organizations that produced various e-notarization technologies or that had implemented e-notarization programs including Countrywide, Adobe, Simplifile, EDL, National Notary Association, WorldWide Notary and the Commonwealth of Pennsylvania.

Having considered the North Carolina Electronic Notary Act, other states' successes and disappointments with electronic notarization programs and the availability of user-friendly e-notarization applications, the Council makes the following recommendations. The Council recognized the importance of and sought to identify standards for electronic notarization that were both technology-neutral and capable of satisfaction by multiple technologies. The Council believes that the following standards are reasonable and appropriate to assure adoption and implementation of secure electronic notarization in North Carolina.

1. Physical Appearance Requirement

- a) Physical appearance embodies the notion that the principal and the notary public are in each other's physical presence so that they can see, hear, communicate with, and give identification documents to each other without reliance on electronic devices such as telephones, computers, video cameras, or facsimile machines.

2. Security Requirements

- a) Each electronic signature requiring notarization should be individually affixed to the electronic document by the principal signer and should be acknowledged separately by the signer prior to the notarial act. This provision is not intended to prevent a single acknowledgment certificate being used for multiple signatures of a single principal or single signatures by multiple signers.
- b) The electronic notary signature and or electronic notary seal should only be issued to a notary by a vendor utilizing technology which meets or exceeds standards put forth by the Secretary of State after the notary has qualified as an electronic notary public.
- c) Employers should immediately relinquish the electronic notary seal, which may or may not also contain the electronic notary signature, to a notary who is no longer employed by such company, as the electronic notary seal is the sole property of the notary public even in the case where the employer purchased the electronic notary seal.

- d) As a part of the approval process to grant a notary the authority to perform electronic notarizations, the Secretary of State should send electronic notification of the notary's qualification to act as an electronic notary to the register of deeds in the county of the notary's commission.
- e) The electronic notary seal is the private property of the Notary and should be subject to laws governing private property.
- f) Access to electronic notary signatures and electronic notary seals should be protected by the use of a password, token, biometric or some similar form of authentication.

3. Elements of the Electronic Notary Act

Electronic Signature

- a) For documents executed in paper form, the Notary must affix the original signature and seal on paper.
- b) The electronic notary signature should be independently verifiable; unique to the Notary; remain in the sole control of the notary; be attached to or logically associated with the document; and link the data in such a manner that any subsequent alterations to underlying documents or electronic notary certificate are detectable
- c) An image of the notary's manual signature should appear on any visual representation of an electronic notary certificate regardless of the technology being used to affix the notary's electronic signature.

Electronic Seal

- d) The electronic seal should be capable of independent verification; unique to the notary; remain in the sole control of the notary pursuant to N.C. Gen. Stat. § 10B-50(b); be attached to or logically associated with the document; and link the data in such a manner that any subsequent alterations to underlying documents or electronic notary certificate are detectable.
- e) All entities providing electronic notary seals and electronic notary signatures meeting specifications, as set forth by the Secretary of State, should provide a free and readily available viewer or reader to enable all parties relying on the electronically notarized document to view the electronic notary signature and the electronic notary seal without incurring any cost.

4. Registration of technology and e-notarization capability

- a) In registering the capability to perform electronic notarial acts, the notary public should provide to the Secretary of State the technology used to attach an electronic notarial certificate, an electronic signature and or an electronic seal; the electronic signature and electronic notary seal attached to the e-notary registration form; and instructions or techniques that allow the notary's electronic signature and/or official electronic seal to be read.

- b) The notary should provide proof of successful completion of the three hour required educational course of instruction at the time of registration.
- c) The notary should have completed the three hour required course of instruction within three months preceding registration and must answer at least eighty percent (80%) of the questions correctly in order to pass the exam.
- d) The notary should inform the Department of any changes in his or her registration information within 24 hours of the change. Portions of the online registration form should be accessible to the notary to enable said notary to update his or her registration information including a change in technology, email addresses, physical addresses or phone numbers.

Additional Recommendations

In addition to the recommended standards set forth above, the Council additionally discussed and recommends to the Secretary that the Department consider:

- 1. Revision to N.C. Gen. Stat. § 10B-126(c) to read: "A notary shall do the following within 24 hours of discovering that the notary's electronic seal or electronic signature has been lost, stolen, damaged, or otherwise rendered incapable of affixing a legible image: (1) Inform the appropriate law enforcement agency in the case of theft or vandalism. (2) Notify the Register of Deeds of the county in which the Notary Commission was issued by recording an affidavit of such in the official name in which he or she was commissioned and a written notice to the Secretary of State. (Said written notice to the Secretary may be a copy of the affidavit filed in the Register of Deeds.
- 2. Revision to N.C. Gen. Stat. § 10B-126(c) to specify what actions the Register of Deeds and law enforcement officials should take upon receiving written notification of a lost or stolen notary seal since the current language may not achieve the intended result of the statute.
- 3. Revision to N.C. Gen. Stat. § 10B-117 to state that the requirements of this section are met so long as the information is contained within the Notary Seal.
- 4. Revision to N.C. Gen. Stat. § 10B-117(5) to include the electronic seal.

Additional Comments

In addition to the standards and additional recommendations set forth above,

- 1. The Council had substantial discussions regarding a potential journal requirement for electronic notarial acts. The Council recognizes that there are substantial and legitimate differences of opinion, including within the Council, regarding whether such a journal should be required. If such a journal were required, the Council further recognized that there are substantial and legitimate differences of opinion, including within the Council, regarding what information should be captured by such a journal. An electronic journal requirement raises

significant issues regarding consumer protection, business processes, as well as confidentiality concerns in law and medical offices, among others.

The Council has no recommendation to the Secretary at this time regarding a potential journal requirement. If the Secretary determines that a journal requirement is appropriate, members of the Council expressed a current willingness to further advise the Secretary if so requested.

2. The Council recognized that current technology makes it simple for a document to transition from paper to electronic form, and vice-versa, perhaps several times during the useful life of a document. The general sense of the Council was that if a notarial act is to be applied to a document, that the notarial act should occur in the same medium (i.e., paper or electronic) as the principal execution of the document. Related issues include government acceptance for "hard-copy" filing of paper reproductions of electronically executed and notarized records, which may require revision to recording and probate legislation, among others.

3. The Council recognized that the issuance of apostilles and certificates of authentication will continue to conform to the Hague Convention Abolishing the Requirement of Legalization for Foreign Public Documents. This is a topic appropriate for common international standards, and as such the Council makes no recommendations on this topic.

Approved by unanimous vote of the Council on June 20, 2006, and respectfully submitted, this the 21 day of June, 2006.

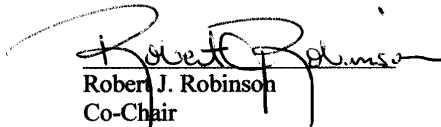
Robert J. Robinson
Co-Chair

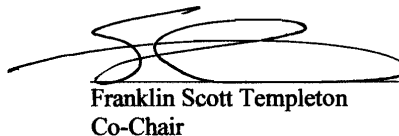
Franklin Scott Templeton
Co-Chair

ADDENDUM N

North Carolina's Real Estate Recording Laws: The Ghost of 1885

Reprinted by permission from North Carolina Central Law Journal

Spring 2006, Volume 28, Number 2

Copyright 2006 by the North Carolina Central University School of Law.

All rights reserved.

NORTH CAROLINA'S REAL ESTATE RECORDING LAWS: THE GHOST OF 1885

CHARLES SZYPSZAK*

I. INTRODUCTION

Private real estate ownership depends on reliable public records. Conveyance laws provide those who acquire real estate interests with a way to record their rights to protect themselves against competing conveyances of the same interests. Purchasers and lenders rely on these records to assess the likelihood that those with whom they are dealing own real estate free of competing claims.

North Carolina is one of the very few states clinging to a “pure race” recording system, which is characterized simply as “first to record, first in right.” Unlike the recording statutes common elsewhere, North Carolina’s laws are intended to limit the inquiry of real estate interests to the public record, by eliminating the need to consider other information that may be available about a competing claim. This intended purity has proved to be an illusion. The real estate records give an incomplete picture of property rights. Courts have used their equitable powers to reorder the priority of rights that the records depict. Lawmakers have created liens that can apply without having to appear in the real estate records. Courts have denied the recording benefits to instruments deemed to have been prepared improperly. In a fairly recent development, the records have been used as a tool for harming rather than protecting property interests. These realities make the recording laws far less simple than they may appear, and raise questions about whether the statutes could be a more comprehensive and coherent statement of the rules.

This article discusses the nature of the race recording statute and the major conceptual and practical issues that have arisen in its application. Part II discusses the statute and the extent to which it truly results in a pure record as originally envisioned. It also considers how the statute could be amended to reflect the law as it is actually applied. Part III describes undue risks to legitimate conveyances posed by requiring strict compliance with recording rules, and examines possible refinements to the laws to address these risks. Part IV describes

* Associate Professor of Public Law and Government, School of Government, The University of North Carolina at Chapel Hill.

abuse of the recording system and possible legislative responses to the problem.

II. THE MISLEADING NOTION OF PURE REAL ESTATE RECORDS

In the United States, real estate conveyances are governed by state law. All states have recording offices for real estate instruments and laws that govern the effect of recording, including how disputes are resolved if there is a conflict between the sequence of conveyances and the order in which instruments are recorded. Most of the states' laws share the same essential features, which take into account both the order of recording and any notice a claimant may have had about a prior, competing conveyance. North Carolina still retains a statute that seems to make no exception to the recording requirements based on such prior notice. The statute's express language can be misleading, however, because the courts and the legislature have recognized or created many important exceptions to priorities shown on the public record.

A. *Recording Laws*

Real estate recording laws have two main goals. The first goal is to give those who acquire interests legitimately a means of protecting against otherwise undetectable competing claims. The laws do this by giving priority to interests that are first recorded publicly. The second goal is to provide those interested in acquiring interests in real estate, either by purchase or as security for a loan, a way to assess the validity of the rights claimed by those with whom they are dealing.¹ The laws do this by requiring real estate instruments to be recorded. To accomplish both of these goals, the recording laws must resolve conflicting claims predictably and fairly.

Without a recording statute, if two grantees are conveyed the same real estate, the first conveyance will be acknowledged as effective because the grantor had nothing left to give when the second conveyance was made. Only application of an overarching equitable principle will alter this outcome. The recording laws can change the result based on either or both of two factors: the sequence in which the instruments of conveyance were recorded, and notice obtained by means other than the records about a prior conflicting claim, usually from actual knowledge about an unrecorded instrument.

1. See *Bd. of Selectmen of Hanson v. Lindsay*, 829 N.E.2d 1105, 1109-10 (Mass. 2005) (discussing the "two interconnected" purposes of real estate recording of protecting purchasers from undisclosed claims and giving them a means of detecting such claims).

Recording laws take three forms: notice, race-notice, and race. Of the three, the notice rules depend the least on the public records. A typical notice statute provides that no instrument conveying real estate will “be effectual to hold such lands against any person but the grantor and his heirs, unless the deed or conveyance is acknowledged and recorded.”² This means that if an instrument of conveyance is recorded, everyone else is deemed to have constructive notice of the conveyance and to be bound by it. As with all recording systems, an unrecorded instrument will not bind a subsequent purchaser or creditor who does not otherwise know about it.³

Many states have “race-notice” recording laws. A common version provides that real estate instruments become enforceable when recorded “as to all creditors and subsequent purchasers in good faith without notice,” but instruments are “void as to all creditors and subsequent purchasers without notice whose deeds, mortgages or other instruments are recorded prior to such instruments.”⁴ This type of statute denies priority to a second grantee with actual notice about an unrecorded prior conveyance, but requires that the second grantee record the instrument to be entitled to the statute’s benefits.

North Carolina is one of the very few states with a “pure” race recording statute. North Carolina’s statute provides that no deed or other instrument of conveyance “shall be valid to pass any property interest as against lien creditors or purchasers for a valuable consideration from the donor, bargainor or lessor but from the time of registration thereof in the county where the land lies.”⁵ Notice plays no role in this statute, only *registration*, which refers to the status of being properly recorded (the word “recorded” is used in this article to refer to an instrument’s presence in the records, which may or may not be deemed to be registration under the law).⁶ A familiar refrain in North

2. VT. STAT. ANN. tit. 27, § 342 (1989).

3. See *Hemingway v. Shatney*, 568 A.2d 394, 396 (Vt. 1989) (describing Vermont’s notice statute).

4. NEB. REV. STAT. § 76-238 (2003).

5. N.C. GEN. STAT. § 47-18(a) (2005). The same language is used in different statutes for deeds, *id.*, security instruments, § 47-20, and easements, § 47-27. Louisiana, with its unique legal system, is the other state with what is still described as a pure race recording statute. LA. CIV. CODE ANN. § 3338 (West Supp. 2006).

6. North Carolina has a Torrens Act by which title to real estate can be confirmed by a court decree and then ownership (not just the instrument) can be registered. N.C. GEN. STAT. §§ 43-1 to -64 (2005). The Torrens system was adopted by a number of states in the early twentieth century but was unsuccessful. It was used mostly by holders of large tracts that wanted and could afford to obtain title assurances from the government greater than the ordinary recording system could provide. It never received widespread acceptance and has been displaced by title insurance. See Charles Szypszak, *Public Registries and Private Solutions: An Evolving American Real Estate Conveyance Regime*, 24 WHITTIER L. REV. 663 (2003) (comparing the recording and Torrens systems and the private alternatives that evolved); Frederick B. McCall, *The Torrens System—After Thirty-Five Years*, 10 N.C.L. REV. 329, 335 (1932) (stating in 1932 that “[t]he

Carolina is that “no notice to the purchaser, . . . however full and formal, will supply the place of registration.”⁷ Ostensibly this means that those who record first will have title even if they knew someone else was already conveyed the same property. With notice and race-notice laws, the second grantee’s actual knowledge of the prior conveyance could result in subordination even though the second grantee records first.

Many of the states’ original recording laws were race-type statutes but were later modified to take notice into account.⁸ A number of states have race-type statutes for mortgages but not for deeds.⁹

B. *Registration Required*

North Carolina’s first laws required that deeds go before a court before being recorded with the county register of deeds.¹⁰ This record could then be used as evidence of ownership,¹¹ but the statutes did not set rules about resolving competing claims based on actual notice of an unregistered deed. Prior to 1885, an unregistered deed was considered to be a legal conveyance and courts looked to the situational equities to determine whether someone who knew of a prior competing conveyance should be denied ownership despite being the first to record.¹² Actual notice was, therefore, as important as recording. The North Carolina Supreme Court stated that when a purchaser knew someone else had a deed to the same real estate, “he is affected with notice of every part of its contents.”¹³ The court reasoned that “an incomplete legal title” existed when the deed was delivered, which could ripen into “a perfect legal title” upon registration retroactive to the deed’s delivery.¹⁴ The equitable merits of the first grantee’s situation could be shown by parol evidence.¹⁵

In 1829, North Carolina began to strictly require a security instrument, such as a deed of trust, to be registered first in order to have priority as a lien on the real estate.¹⁶ Without a registration require-

Torrens law is practically a dead letter so far as this state is concerned”). The continued existence of the Torrens law should be reconsidered in view of the burdens it continues to place on registers despite its very limited utility, but that is a subject beyond the scope of this article.

7. *Quinnerly v. Quinnerly*, 19 S.E. 99, 99 (1894) (quoting *Robinson v. Willoughby*, 70 N.C. 358, 364 (1874)).

8. 14 Powell on Real Property § 82.02[1][c][i] (Michael Allan Wolf ed. 2005).

9. *E.g.*, ARK. CODE ANN. § 18-40-102 (2003).

10. 1715 N.C. Sess. Laws 38 § 5.

11. 1756 N.C. Sess. Laws 6 § 3.

12. *See Ray v. Wilcoxon*, 12 S.E. 443, 447 (N.C. 1890) (remanding title dispute “for an equitable adjustment of the rights of the parties”).

13. *Walker v. Coltraine*, 41 N.C. 79, 82 (1849).

14. *Phifer v. Barnhart*, 88 N.C. 333, 338 (1883).

15. *Robinson v. Willoughby*, 70 N.C. 358, 363 (1874).

16. Act effective 1829, ch. 20, 1829 N.C. Sess. Laws 23.

ment, creditors could withhold their instruments from public view. This enabled debtors to obtain credit from other lenders who were unaware of the prior credit. When the first lenders later registered their mortgages, they would still take priority over the innocent second lenders.¹⁷ The 1829 law provided that “[n]o deed of trust or mortgage . . . shall be valid at law to pass any property as against creditors or purchasers, for a valuable consideration from the donor, bargainor or mortgagor, but from the registration of such deed of trust or mortgage in the county where the land lieth”¹⁸ The North Carolina Supreme Court stated that this requirement “was intended to uproot all secret liens, trusts, unregistered mortgages, etc., and under its force it has been held that no notice, however full and formal, will supply the place of registration.”¹⁹

In 1885, the same rule was applied to deeds by a statute providing that no deed “shall be valid to pass any property interest as against lien creditors or purchasers for a valuable consideration from the donor, bargainor or lessor but from the time of registration thereof in the county where the land lies.”²⁰ This law was known as Connor’s Act, named for the state senator and judiciary committee chair, Henry Groves Connor, who sponsored it. That same year, Connor became a superior court judge. Later he was speaker of the house, an associate justice for the state supreme court for which he wrote important decisions interpreting the statute, and a federal judge.²¹ Justice Connor

17. *Leggett v. Bullock*, 44 N.C. 283, 286 (1853).

18. Act effective 1829, ch. 20, 1829 N.C. Sess. Laws 23 (codified at Code of N.C. ch. 27, § 1254 (1883) (current version at N.C. GEN. STAT. § 47-20 (2005))).

19. *Hooker v. Nichols*, 21 S.E. 207, 208 (N.C. 1895).

20. Connor’s Act, ch. 147, sec. 5, 1885 N.C. Sess. Laws, 234 (codified at N.C. GEN. STAT. § 47-18(a) (2005)). In 1943, the same race recording language was added to a statute specifically applying to easements. Act effective 1943, ch. 750, 1943 N.C. Sess. Laws (codified at N.C. GEN. STAT. § 47-27 (2005)).

21. Connor’s Act was part of a political climate that sometimes employed the law as a tool of exclusion, a goal that all legislators should now agree is illegitimate. Henry Groves Connor was among the leading Southern Democrats who became known for advocating racial segregation in the late 1800s and early 1900s. While speaker of the house in North Carolina he was a supporter of the infamous “Grandfather’s Clause” amendment to the state’s constitution. Editorial Notes, *Henry Groves Connor*, 2 N.C.L. REV. 228, 229 (1924) (“Judge Connor was a real leader in the famous legislature of 1899, which restored ‘white supremacy’ by the passage of the constitutional amendment requiring an educational qualification for voting.”). The 1900 amendment limited voting rights to those who could read and write the state’s constitution, except for those who were able to vote in 1867 or their descendants, which was when only white people could vote. Act Effective 1899, N.C. Sess. Laws 218; Act of 1900, N.C. Sess. Laws 2 (enacted at N.C. CONST. of 1868, art. VI, § 4 amended by N.C. CONST. art. VI (1971)). The Republican Party platform opposing the Democrats in 1900 said that “the Democratic leaders have determined to wage the coming campaign upon the race issue alone, and they go before the people with a scheme of disfranchisement which is the most impudent assault upon the Constitution of the United States, and the most shocking act of perfidy ever attempted by men who recognize the obligation of an oath or the sanctity of a public pledge.” Republican Party Platform 1900, reprinted in HUGH T. LEFLER, NORTH CAROLINA HISTORY AS TOLD BY CONTEMPORARIES 405,

said that when the law was enacted, the state was “an inviting field for the investment of capital in the development of its resources in mines, lumber, water-power and agriculture,”²² but suffered from “the laxity of our registration laws,” by which the holder of an unrecorded deed could obtain priority rights upon registration retroactive to the date of the delivery of the deed.²³ He noted that “frequent efforts were made to place deeds in respect to registration as affecting purchasers and creditors on the same footing with mortgages and deeds in trust,” and in 1885 the efforts succeeded.²⁴

Formal deed recording requirements must have encouraged real estate investments, but they could not have been intended to promote widespread real estate ownership by those who already occupied the land. In 1885 there were many landholders who were unsuited to comply with rigorous instrument preparation and recording requirements. They included former slaves, of whom there were more than 350,000 in North Carolina after the Civil War.²⁵ A small, but not insignificant, percentage of freed persons occupied land they believed they owned. However, they encountered difficulties when arranging for credit and meeting other demands of ownership, and they were frequent victims of fraud.²⁶ Another large group of vulnerable landholders were sharecroppers, tenants, and small farmers. Tenant farmers operated more than one-third of North Carolina’s farms.²⁷ Connor’s Act was obviously not intended to protect these groups who were not likely to be familiar with methods of formalizing ownership, and were also unlikely to have access to lawyers for assistance.²⁸

The plight of disadvantaged landholders was not mentioned in the public record when the need for the 1885 law was described, but Justice Connor did acknowledge that a strict registration requirement was a “radical . . . change and departure from the law and policy which

405-06 (Hugh T. Lefler, ed., U.N.C. Press 1956). Although the state’s recording law cannot fairly be attributed primarily to white supremacy, the continued desirability of any law should be examined with some consideration of the context in which it was enacted.

22. *Laton v. Crowell*, 48 S.E. 767, 767 (1904).

23. *Id.*

24. *Id.*

25. MILTON READY, *THE TAR HEEL STATE: A HISTORY OF NORTH CAROLINA* 250 (U.S.C. Press 2005).

26. See SHARON ANN HOLT, *MAKING FREEDOM PAY: FREED PEOPLE WORKING FOR THEMSELVES, 1865 – 1900*, 60 J.S. HIST. 229, 259 (1994) (“sometimes fraud in the drawing up or filing of land deeds necessitated paying twice or thrice over for the same form”).

27. HUGH TALMAGE LEFLER & ALBERT RAY NEWSOME, *THE HISTORY OF A SOUTHERN STATE: NORTH CAROLINA* 522 (3d ed. 1973).

28. See generally, *Avent v. Arrington*, 10 S.E. 991, 996 (1890) (stating most landholders would understand that a deed is important but few would appreciate the subtleties of preparing and recording the deed including the rules for a proper acknowledgment of the signature, the court saying that “only one educated in the law could be expected to understand that a seal was necessary to make it, in reality, a deed, and vest the estate in the grantee”).

had prevailed for more than a century.”²⁹ To spread the word about the new requirements, the legislation required the secretary of state, court clerks, and registers to publish notice about them.³⁰ The legislation allowed a grace period for registering deeds, and an exception for unregistered deeds executed prior to the statute’s effective date if the claimant or claimant’s tenants had possession when the conflicting deed was executed, or if the grantee of the conflicting deed had actual or constructive notice of the prior, unregistered deed.³¹ Notice was therefore relevant only to conveyances prior to 1885.³²

For conveyances after 1885, application of the statute could have harsh results, as illustrated by *Grimes v. Guion*,³³ in which a woman defended a claim of ownership based on possession and improvement of the property. She alleged that the owner was facing foreclosure and asked her to pay the taxes and make a loan. The defendant said the owner invited her to take possession, to cultivate the land, and to improve the structures. Further, the defendant said the owner promised that if she did not repay to the defendant all amounts expended before the owner died, the defendant would own the property. The defendant made investments as agreed but was not repaid. The owner’s heirs gave a recorded deed to someone whom the defendant said was fully aware of her investment and claim. The defendant’s counsel described his client as “an ignorant colored woman, without education.”³⁴ The court was not moved by her situation and said:

Though the defense attempted to be set up by defendant portrays her as the victim of a grievous wrong, which engenders indignation and invokes sympathy, it states no cause of action against plaintiff. There is no averment that he has either assumed, or broken any obligation to her. Rather, the averments indicate that he has acted within the registration laws as written.³⁵

Strict application of the registration law can also enable a purchaser to invalidate interests that should have been obvious when the property was acquired. In *Rowe v. Walker*,³⁶ owners of land situated across two counties challenged a farm road easement. The owners acquired their land by a single deed describing the property in both counties. But the deed that created the easement was recorded in only one of the counties when the easement beneficiaries purchased their prop-

29. *Laton*, 48 S.E. at 768.

30. Connor’s Act ch. 147, sec. 5, 1885 N.C. Sess. Laws, 234.

31. *Id.* at sec. 1, 233.

32. *See Laton*, 48 S.E. at 768.

33. 18 S.E.2d 170 (N.C. 1942).

34. *Id.* at 171.

35. *Id.* at 173.

36. 441 S.E.2d 156 (N.C. Ct. App. 1994), *aff’d*, 455 S.E.2d 160 (N.C. 1995).

erty.³⁷ A title search should have been done in both counties when the land was purchased, and the easement instrument and its effect on land in both counties should have been noticed. But the easement recording statute states that no “easement of any character shall be valid as against any creditor or purchaser for a valuable consideration but from the registration thereof within the county where the land affected thereby lies.”³⁸ A majority of the court of appeals said this meant that registration in one county does not bind others with respect to real estate in another county.³⁹ The appellate court rejected the trial court’s ruling that the law “require[s] a purchaser for valuable consideration to be an ‘innocent purchaser.’”⁴⁰ A dissenting judge found this to be an unacceptable result.⁴¹ Relying on terminology loosely employed in two state supreme court cases,⁴² the dissent said that the statute’s qualification that registration applies to a “purchaser for a valuable consideration” required that the party seeking the statute’s benefits must have been acting in good faith, which included acting without knowledge of the contested right.⁴³ But a good faith requirement is not part of the statutory language; its absence is a distinguishing feature of a pure race recording statute. The dissent’s statutory interpretation may have been creative but the motivation to arrive at an equitable result was understandable.

C. *Statutory Impurity*

Contrary to the announced goals of a pure race recording statute, there are many potential claims to real estate that are not shown by the public records. Purchasers, title examiners, and title insurers must investigate other records and other circumstances to be sure a real estate title is what the owner represents it to be.

37. *Id.* at 157.

38. N.C. GEN. STAT. § 47-27 (2005).

39. *Rowe*, 441 S.E.2d at 158.

40. *Id.*

41. *Id.* at 159 (John, J., dissenting).

42. For the good faith requirement the dissent gave the following authority: “*Hill v. Pine-lawn Memorial Park*, 304 N.C. 159, 165, 282 S.E.2d 779, 783 (1981) (N.C. recording statutes ‘do[] not protect all purchasers, but only *innocent* purchasers for value’) (emphasis added) (citations omitted); see also *Green v. Miller*, 161 N.C. 24, 31, 76 S.E. 505, 508 (1912) (purchaser *without notice* of right or interest of third party, who pays full and fair price at time of purchase or before notice, takes property free from right of third party ‘because he is regarded as an innocent purchaser It is a perfectly just rule, and it would be strange if the law were otherwise’) (emphasis added).” *Id.* In *Hill*, the court recognized an exception to the registration requirement for actual knowledge of pending litigation. 282 S.E.2d at 783. In *Green*, the court considered whether a landowner was estopped from denying the public dedication of roads shown on the subdivision plan. 76 S.E. at 506-09. These exceptions to the registration requirement are discussed *infra* in the text accompanying notes 62 and 65 to 68.

43. *Rowe*, 441 S.E.2d at 160-61.

The recording laws apply to third parties.⁴⁴ Failure to record is not a defense against a grantee's enforcement of an instrument against its grantor.⁴⁵ Also, a deed obtained fraudulently,⁴⁶ or without valuable consideration, does not enjoy the statute's protection.⁴⁷ These exceptions follow from the statutes' identification of "creditors or purchasers for a valuable consideration" as those who are protected.⁴⁸

The courts have made a number of important exceptions to recording priority that are not reflected in any statute's text. An owner will be held subject to rights described in an unrecorded instrument if the unrecorded instrument is incorporated by reference into the owner's deed or another recorded instrument in the chain of title. For example, the North Carolina Supreme Court held that an owner was bound by an agreement to recognize unrecorded leases because the agreement was mentioned in the owner's deed.⁴⁹ The court has reasoned that someone acquiring title with such a reservation is either estopped from denying its effect,⁵⁰ or that the grantee takes the property in trust subject to the conveyance to which reference was made.⁵¹

Parties' relative rights have been realigned based on other equitable theories as well. For example, in *Hice v. Hi-Mil, Inc.*,⁵² a deed included more property than the parties intended. One of two grantees re-conveyed his interest to the other. The grantee with the entire interest then transferred the property to a corporation the two had formed.⁵³ The corporation thereby acquired title to the erroneously included land with no competing claim on the record. Based solely on the recording laws, the corporation would have uncontested ownership. But the North Carolina Supreme Court went beyond the stat-

44. See, e.g., *Bowden v. Bowden*, 141 S.E.2d 621, 627 (N.C. 1965) ("The registration of deeds is primarily for the protection of purchasers for value and creditors; an unregistered deed is good as between the parties and the fact that it is not registered does not affect the equities between the parties.").

45. *Patterson v. Bryant*, 5 S.E.2d 849, 851 (N.C. 1939).

46. *Twitty v. Cochran*, 199 S.E. 29, 30 (N.C. 1938) (explaining that the statute did not give priority to recorded deed over unrecorded deed when the former was "a voluntary one made for a fraudulent purpose").

47. *Paterson v. Bryant*, 5 S.E.2d at 851 (holding that the first to record prevails "in the absence of fraud or matters creating an estoppel").

48. N.C. GEN. STAT. §§ 47-18(a), -20, -27 (2005).

49. *State Trust Co. v. Braznell* 41 S.E.2d 744 (N.C. 1947).

50. *Hardy v. Abdallah*, 133 S.E. 195 (N.C. 1926) (subordinating mortgage to subsequently recorded mortgage mentioned as an exception to the warranty against encumbrances).

51. See *Terry v. Brothers Inv. Co.*, 334 S.E.2d 469 (N.C. Ct. App. 1985) (subjecting deed to lease identified in prior deed in chain of title); *Bourne v. Lay & Co.*, 140 S.E.2d 769 (N.C. 1965) (holding that rule did not apply to a reference to a prior lease with a disclaimer of any warranty regarding its effect); *Hardy v. Fryer*, 139 S.E. 833 (N.C. 1927) (subordinating mortgage to subsequently recorded mortgage mentioned as an exception to the warranty against encumbrances in a prior deed in the chain of title).

52. *Hice v. Hi-Mil, Inc.*, 273 S.E.2d 268 (N.C. 1981).

53. *Id.* at 269-70.

utes to avoid an inequitable result, ordering that the deed be reformed because the individuals' knowledge was imputed to the corporation and the corporation therefore was not "an innocent bona fide purchaser for value" without notice.⁵⁴ The recording law, however, says nothing about a purchaser having to be innocent.

The courts also have avoided the law's potential for inequity by wielding the sometimes omnipotent constructive trust concept. In *Arnette v. Morgan*,⁵⁵ for example, the court used a constructive trust to address conflicts arising from a recorded deed that had omitted part of the land intended to be conveyed. After the conveyance, a judgment creditor recorded a lien against the grantor, who still had title to the omitted land according to the public record. The court of appeals held that the grantor held the property in a constructive trust for the intended grantee's benefit, which made the recording law inapplicable to consideration of the relative rights of the creditor and the intended grantee. The court then insisted that the creditor must be "bona fide purchaser for value without notice or someone occupying similar status" to prevail, and because the creditor did not prove it was so qualified, the deed was reformed to convey the property to the grantee free of the creditor's lien.⁵⁶

There are also circumstances in which third parties can acquire rights in real estate without first recording an instrument. For example, ownership rights to real estate can be acquired without a deed by adverse possession based on open and continuous occupation to the exclusion of others, without permission, for at least twenty years.⁵⁷ North Carolina shortens the required possession period to only seven years when someone occupies the property under color of title,⁵⁸ which can be based on a written instrument purporting to convey land but failing to comply with formal requirements.⁵⁹ The color of title doctrine evolved to protect settlers who worked land relying on in-

54. *Id.* at 272.

55. *Arnette v. Morgan*, 363 S.E.2d 678 (N.C. Ct. App. 1988).

56. *Id.* at 680.

57. N.C. GEN. STAT. § 1-40 (2005); *Locklear v. Savage*, 74 S.E. 347, 348 (N.C. 1912); see generally PATRICK A. HETRICK & JAMES P. McLAUGHLIN, JR., *WEBSTER'S REAL ESTATE LAW IN NORTH CAROLINA*, ch. 14 (5th ed. 1999) (discussing adverse possession in North Carolina). For an excellent example of how adverse possession can overcome a registration problem, see *McClure v. Crow*, 146 S.E. 713 (N.C. 1929), in which the North Carolina Supreme Court remanded a case for a new trial on the question of rights by possible adverse possession after determining that a deed's registration was invalid because it lacked a required witness acknowledgment.

58. N.C. GEN. STAT. § 1-38 (2005); *Price v. Tomrich Corp.*, 167 S.E.2d 766, 770 (N.C. 1969); see generally Monica Kivel Kalo, *The Doctrine of Color of Title in North Carolina*, 13 N.C. CENT. L.J. 123 (1982) (discussing the doctrine of color of title).

59. See *Price v. Tomrich Corp.*, 167 S.E. 2d 766, 770 (N.C. 1969) ("Color of title is generally defined as a written instrument which purports to convey the land described therein but fails to do so because of a want of title in the grantor or some defect in the mode of conveyance.").

struments they mistakenly believed to have conveyed good title to them,⁶⁰ and survived adoption of the current recording statute.⁶¹

Another exception to the recording requirement is the enforceability of easement rights based on a development plan. The North Carolina Supreme Court has held that “a purchaser is bound to take notice of an apparent easement, servitude, or dedication for a street or other way [shown on a plan to which a deed refers or that is physically apparent]; and if he fails to do so, he buys at his peril and takes his title subject thereto.”⁶² This rule is applied when a subdivision plan shows access roads for use of the lots within the subdivision, but the deeds for the lots neglect to state expressly that these rights to the roads were included. The courts do not allow the absence of a recorded instrument to prevent purchasers from having access to the development’s clearly intended benefits.

A number of exceptions to the recording requirement have also been created legislatively. One often contentious exception applies to pending litigation. In some states, the only way for a litigant to acquire rights in real estate in connection with litigation is to obtain a court-ordered attachment and record the order in the real estate records.⁶³ Consequently, even in a race-notice jurisdiction, a prospective purchaser or creditor can rely safely on the register’s records for information about litigation liens. In North Carolina, and in some other states, such liens need not be recorded with the register. North Carolina’s pending litigation, or *lis pendens* lien, is indexed in the superior court records, which binds later purchasers and creditors to the outcome of the pending proceeding.⁶⁴

The possible effects of litigation on real estate titles extend even beyond rights that can be determined based on the superior court records. In *Lawing v. Jaynes*,⁶⁵ the North Carolina Supreme Court held that purchasers and creditors acquiring real estate interests are subject to judgments arising from litigation of which they had actual knowledge.⁶⁶ The court spoke of a purchaser’s obligation “to show that he is a purchaser for a valuable consideration and, when an action is pending which affects the title to the property, that he had no actual

60. See Kalo, *supra* note 58, at 131-132 (discussing the origins of the color of title doctrine).

61. See *Collins v. Davis*, 43 S.E. 579, 581 (N.C. 1903) (discussing continued viability of the color of title doctrine after adoption of the recording statute in 1885).

62. *Green v. Miller*, 76 S.E. 505, 509 (N.C. 1912) (but holding that there was insufficient evidence of knowledge of the road dedication).

63. *E.g.*, N.H. REV. STAT. ANN. § 511:3 (1997); see *Manchester Fed. Sav. & Loan Ass’n v. Letendre*, 164 A.2d 568, 572-73 (N.H. 1960) (discussing New Hampshire’s attachment lien procedure).

64. N.C. GEN. STAT. § 1-118 (2005).

65. *Lawing v. Jaynes*, 206 S.E.2d 162 (N.C. 1974).

66. *Id.* at 171.

notice of such action.”⁶⁷ Again, the state’s recording laws were intended to make actual notice irrelevant. But the state’s supreme court said that “[w]here a purchaser claims protection under our registration laws, he has the burden of proving by a preponderance of the evidence that he is an innocent purchaser for value, *i.e.*, that he paid valuable consideration and that he had no actual notice, or constructive notice by reason of *lis pendens*, of pending litigation affecting title to the property.”⁶⁸

There are many other interests that can affect real estate that are not required to be recorded with the register of deeds. A judgment affecting real estate docketed in superior court will have priority over any subsequently acquired security interest in the real estate.⁶⁹ North Carolina statutes grant those who provide labor or materials for improvement of real estate a lien on the property, effective from the date the labor or materials are first provided, which can be perfected with an action in superior court until four months after the labor or materials were last provided.⁷⁰ A lien for municipal and county real estate taxes attaches when the property is listed for taxes annually and has priority over other liens.⁷¹ Federal environmental liens can be created with a filing in the federal district court.⁷² Consequently, to protect themselves, purchasers and creditors must examine court records, tax records, and make inquiries about recent construction for information not required to be recorded at the register of deeds.

A final example of how recording gives an incomplete picture of real estate rights is the passage of title by will or intestate succession. Competing claims based on inheritance are determined based on the governing estate planning instruments and laws of succession.⁷³ Justice Connor, the sponsor of North Carolina’s recording law, instructed that the recording law “applies only to deeds, contracts to convey, and leases of land. The statute is directed to the protection of creditors and purchasers for value. The evil which [the statute] was intended to remedy was the uncertainty of title to real estate caused by persons withholding deeds, contracts, etc., based upon a valuable consideration, from the public records. This evil could not exist in regard to wills, as the devisee [is] not a purchaser for value, but [takes] as donee or volunteer.”⁷⁴ Consequently, those who examine real estate titles

67. *Id.*

68. *Hill v. Pinelawn Memorial Park, Inc.*, 282 S.E.2d 779, 783 (N.C. 1981).

69. N.C. GEN. STAT. § 1-234 (2005); *Moore v. Jones*, 36 S.E.2d 920, 922 (N.C. 1946).

70. N.C. GEN. STAT. §§ 44A-8, -10, -12.

71. N.C. GEN. STAT. §§ 105-355, -356.

72. 42 U.S.C. § 9607(l) (2000).

73. *Bowden v. Bowden*, 141 S.E.2d 621, 627 (N.C. 1965).

74. *Bell v. Crouch*, 43 S.E. 911, 912 (N.C. 1903).

often must look beyond the register's records to the probate records or elsewhere.

This summary demonstrates that the state of the law on real estate recording is not as simple as promised. In 1942, after half a century of experience with the state's race recording rule, the North Carolina Supreme Court described the law in these glowing terms: "Its wisdom has clearly demonstrated itself in the certainty and security of titles in this State which the public has enjoyed since its enactment. It is necessary in the progress of society, under modern conditions, that there be one place where purchasers may look and find the status of title to land."⁷⁵ After another sixty years, those who rely on the records know there is not "one place where purchasers may look" to make such a discovery. Instead, there are other public offices, and other circumstances, that must be examined and considered. It has become an experts' system, and purchasers and creditors must rely on experienced title examiners and modern title assurance mechanisms for protection against adverse liens and claims.

D. *Statutory Clarity*

Several years after North Carolina's race recording statute was enacted in 1885, Justice Clark described the law named after Justice Conner as "[o]ne of the most beneficial laws enacted of late years."⁷⁶ By making the public records a more reliable indication of ownership rights, the law unquestionably improved the marketability of North Carolina real estate in general. The goal of making the public records a reliable determinant of real estate interests continues to have merit, and may actually be more achievable today than it was in 1885. Real estate conveyances and mortgage financing are much different in nature and scale than they were a few decades ago. Real estate transfers occur within a well-developed market, which involves professionals and industries that are very familiar with real estate instruments, recording requirements, and risks of mistakes. Modern secured mortgage financing, which did not begin in earnest until the 1930s, now usually involves standardized instruments and practices. Those whose rights depend on the public real estate records are therefore now more likely to be protected under the recording rules and to have access to professionals who are facile with the process. This includes the vast majority of residential property purchasers, who obtain mortgage financing through lenders who use title companies and attorneys to protect their interests.

75. *Turner v. Glenn*, 18 S.E.2d 197, 200-01 (N.C. 1942).

76. *Cowen v. Withrow*, 17 S.E. 575, 576 (N.C. 1893) (Clark, J., dissenting).

The information contained in the records is also becoming much more accessible. Most registers of deeds now make at least part of their records available to the public on the Internet, and recording electronically with registers is becoming more prevalent. These developments mean that reliance on public records is less likely to displace large groups of disadvantaged claimants as was the case when the race recording laws were first enacted.

North Carolina's state motto is *esse quam videri*⁷⁷ which means "to be, rather than to seem." The state's recording laws are not what they seem. If the race recording approach is to be retained, all who rely on the statutes would benefit if the statutes are clarified to more accurately reflect how rights in real estate are determined. For example, the statutes could be amended to make explicit all exceptions to the recording requirement.⁷⁸ This would include mention of liens obtained by *lis pendens*, tax and judgment liens, and liens for amounts owed for materials and labor applied to the property, as well as rights acquired by adverse possession. The resulting statutes may not be as simple as they now appear, but they would be a more realistic depiction of the law as it really is.

III. RECORDING, REGISTERING, AND REALITY

The rules for any real estate recording system must function to protect those who convey and acquire real estate interests in good faith. In a race recording system, good faith purchasers and creditors must rely on the rights accorded to them as a result of recording their instruments. North Carolina's historic process of subjecting instruments to official review before they could be accepted for recording became incompatible with modern transactional realities. At the same time, the law can still be interpreted to deny the benefits of registration to instruments that have not been properly processed before recording or that contain apparent improprieties in the notary's acknowledgment. These potential complications create significant risks for good faith purchasers and creditors who rely on the laws to protect their interests.

A. *The Magic of Registration*

North Carolina's recording laws protect only instruments that are properly "registered." As interpreted by the courts, being recorded in the register of deeds office does not by itself constitute registration

77. N.C. GEN. STAT. § 144-2 (2005).

78. For an example of such a straightforward acknowledgment of off-record interests, see IOWA CODE ANN. § 558.41(2) (Supp. 2005) (noting that nothing in the statutory priority is intended to abrogate the collection of property taxes).

sufficient to enjoy priority based on the statute. If the document is not something that is permitted to be registered, its recordation has no effect on subsequent purchasers and creditors. The North Carolina Supreme Court once stated that an instrument “does not constitute constructive notice, if it is not of a class which is authorized or required by law to be recorded.”⁷⁹ A document permitted to be registered also can be denied the benefits of the statute if it has not been registered *properly*.

In North Carolina, as in other jurisdictions, the execution of deeds, deeds of trust, and most other real estate instruments must be acknowledged before a notary public or other authorized official before the instruments can be recorded.⁸⁰ This acknowledgment requirement prevents fraud by requiring instrument signatories to establish their identities through the act of signing before public officials who make a record of the event.

In most states, registers have little responsibility for reviewing documents submitted to them for recording. Typically, the law only requires that registers review documents presented for recording for basic indexing information and reproduction quality—not for legal sufficiency or for compliance with acknowledgment form requirements.⁸¹ North Carolina is different. Until recently, officials reviewed the content of instruments before they could be recorded. For example, a register would not accept a deed with a notarial certificate in which the notary’s signature did not exactly match the notary’s name on the seal, or if the certificate was recited in the form of an oath when no oath was required.

The North Carolina process is a remnant of eighteenth century law, when those who wished to register their real estate ownership were required to have their deeds “probated” by the clerk of the superior court who was to determine whether the instruments had been “duly acknowledged.”⁸² When the instruments were adjudged to have been duly acknowledged and the certificates to be in due form, the instruments were ordered by the court to be recorded by the register. In

79. *Chandler v. Cameron*, 47 S.E.2d 528, 531 (N.C. 1948) (recorded personal contract did not give constructive notice) (citing 66 AM. JUR. 2D, *Records and Recording Laws* § 107 (2005)).

80. N.C. GEN. STAT. § 47-17 (2005) (deeds, contracts, and leases). Strictly speaking, an instrument presented for recording may either be “acknowledged” or “proved.” *Id.* An “acknowledgment” occurs when the signatory signs or acknowledges having signed before a notary or other authorized official. N.C. GEN. STAT. § 10B-3(1). A “proof” or “verification” occurs when a witness to someone else’s signature acknowledges the signature. *Id.* § 10B-3(28). Either involves a notary or other authorized official and a certificate recording the act.

81. *E.g.*, N.H. REV. STAT. ANN. § 478:4-a (1989) (amended in 2001) (register empowered to insure suitable, permanent recording of documents submitted to them).

82. N.C. GEN. STAT. § 47-14 (1943) (amended by 1967 N.C. Sess. Laws 639, § 1).

1967, the burden of “probating” was shifted to the registers of deeds,⁸³ and remained with them until 2005. Registers were statutorily directed to register an instrument only after determining that all statutory and locally adopted prerequisites for recording have been met. In addition, until 2005 they were obliged to “pass on” the acknowledgment that appeared on the instrument by determining whether it was in “due form” and “duly proved or acknowledged,” and, if so, they placed a certification to that effect on the instrument and recorded it.⁸⁴ If the instrument was defective it was returned without being recorded.

North Carolina registers’ responsibilities also included an unusually active role in handling records of real estate finance. In most states, after a deed of trust or mortgage has been satisfied, the lender’s representative prepares a simple document and mails it to the register, who records it. Until 2005, North Carolina registers were required by statute to examine satisfactions and their acknowledgments for completeness, accuracy, and form compliance, and in many cases to make entries on the recorded document about the satisfaction.⁸⁵

Legislation that became effective on October 1, 2005,⁸⁶ narrowed the registers’ obligation to review documents that are presented to them for recording. They are no longer required to certify that an instrument has been “duly” acknowledged or that the acknowledgment is in “due form.” Instead, registers review an instrument to see if it “appears to have been proved or acknowledged before an officer with the apparent authority to take proofs or acknowledgements, and the said proof or acknowledgement includes the officer’s signature, commission expiration date, and official seal, if required.”⁸⁷ The 2005 legislation also simplified the process for mortgage lenders to make a record of satisfaction of a deed of trust or mortgage. They can use simple instruments prepared and signed by the trustee or secured creditor and acknowledged, subject to the register’s review only for the presence of a signature and the basic acknowledgment elements.⁸⁸

These changes eliminated a safeguard on which many practitioners relied in the recording process. The result is a system similar to other states, in which the parties and their counsel are solely responsible for the legal sufficiency of the instruments they record and make their own determinations about the sufficiency of other recorded instru-

83. 1967 N.C. Sess. Laws 639, § 1, codified at N.C. GEN. STAT. § 47-14(a) (2003) (amended by 2005 N.C. Sess. Laws 123, § 2).

84. N.C. GEN. STAT. § 47-14(a) (2003) (amended by 2005 N.C. Sess. Laws 123, § 2).

85. *Id.* § 45-37 (amended by 2005 N.C. Sess. Laws 123, § 1).

86. 2005 N.C. Sess. Laws 123, § 1.

87. N.C. GEN. STAT. § 47-14(a) (2005).

88. *Id.* §§ 45-36.10(b)(2), -36.20(e)(2).

ments. But as the process is being changed to make it easier to record without scrutiny, it becomes more likely that an instrument will be recorded with a technical defect.

The limitation of the register's review occurred while form requirements for completing real estate instruments were made more complex, which causes concern for those who rely on the records. There is now a greater chance that a technically defective instrument will be recorded. In 2005, the General Assembly repealed the existing notary laws and enacted a new notary act.⁸⁹ The new notary laws are based on the National Notary Association's model, which is intended to promote notaries as a safeguard against fraud, and which emphasizes rigorous attention to detail in the notarial process and completion of certificates.⁹⁰ By enacting these laws, North Carolina elected not to adopt a simpler Uniform Law on Notary Acts proposed by the National Conference of Commissioners on Uniform States Laws, now in effect in twelve jurisdictions. The uniform law provides simple forms and emphasizes the basic elements of an acknowledgment without insisting on compliance with many details.⁹¹ As a result of the 2005 legislation, the laws now require a notary's name to be typed or printed legibly near the notary's signature; the notary seal must be within the delineated dimensions and contain only specified information without any of the graphics common in existing seals; and the seal must be affixed to the same page as the notary's signature.⁹² Each added requirement raises another possible ground to challenge the legal effect of an instrument without regard to the conveyance's legitimacy, and official scrutiny will no longer protect purchasers or creditors from failures to comply with the requirements.

Purchaser and creditors recording in other states need not be so concerned about technical defects in the form of recorded instruments. Other recording statutes do not deny recognition of recording status based on such defects—recorded instruments that depict the essence of the conveyance will at least be deemed to have given notice of what they describe, which matters in notice and race-notice jurisdictions. Those who represent purchasers and lenders therefore are accustomed to protecting their clients' rights by ensuring that instruments are recorded even if they have minor defects. As a practical matter, any public record of an interest is likely to protect it, be-

89. 2005 N.C. Sess. Laws 391.

90. See Model Notary Act (National Notary Association 2002), at http://www.nationalnotary.org/UserImages/Model_Notary_Act.pdf; Letter from Elaine F. Marshall, North Carolina Secretary of State, to the North Carolina General Assembly (Mar. 16, 2005) (on file with author) (describing proposed changes to the notary laws and the need for regulatory clarification).

91. Uniform Law on Notarial Acts (1982), 14 U.L.A. 201 (2005).

92. N.C. GEN. STAT. §§ 10B-20(b)(2), -36(b), -37 (2005).

cause good faith purchasers and creditors alerted to a possible adverse claim will not proceed with an investment without first seeing that the claim is resolved or making accommodations for the risks it poses. As a result, the modern mantra in the national real estate community is “just get it on the record.” In North Carolina, the statutes and case law continue to cause concern that an unintentional defect in form could result in rejection of the instrument upon presentation for recording or, even worse, denial of registration status sometime after the instrument was recorded.

B. *Recorded but Void*

The requirements for recorded instruments have important implications for the reliability of the records as a depiction of legitimate interests in real estate. North Carolina’s recording laws state that instruments are entitled to protected priority status “from the time of registration thereof.”⁹³ This does not suggest that something more than recording is required. But the North Carolina Supreme Court has consistently held that completion of the recording process is not enough; an instrument is denied the benefits of the statute if it lacks all required components of a *proper* registration. The following rule, as stated by the supreme court, causes much concern among those relying on the records:

Taking the acknowledgment or proof of a deed or admitting it to probate is a judicial or quasi judicial act, and, if the acknowledgment or proof or probate is defective on its face, the registration of the instrument imparts no constructive notice and the deed will be treated as if unregistered.⁹⁴

The question of whether a recorded instrument is entitled to the benefits of the recording act is not unique to North Carolina. As one commentator said in 1944 about the state of the law nationally, “[h]undreds of cases could undoubtedly be cited containing statements that ‘invalid’ or ‘improperly’ recorded instruments, without distinction between substantive and formal invalidity as records, are ‘nullities.’”⁹⁵ The principal justification for this rule has been that an invalidly or improperly recorded instrument would not be allowed as evidence by a court and therefore should not be entitled to be treated as a valid instrument under the recording acts.⁹⁶

93. *Id.* §§ 47-18(a), -20(a), -27.

94. *McClure v. Crow*, 146 S.E. 713, 714-15 (N.C. 1929); *see also* *County Sav. Bank v. Tolbert*, 133 S.E. 558, 560 (N.C. 1926) (“a registration upon a defective probate is invalid and of no effect as to creditors or subsequent purchasers for value”).

95. Francis S. Philbrick, *Limits of Record Search and Therefore of Notice, Part II*, 93 U. PA. L. REV. 259, 288 (1944) (emphasis omitted).

96. *Id.* at 295-96.

The notion that runs contrary to this view has been best described as the obligation of “inquiry notice,” by which someone who sees an instrument is held to be obligated to make a reasonable inquiry into any legitimate rights it describes.⁹⁷ Such notice is likely to matter in all but a pure race jurisdiction. The North Carolina courts have held, however, that “no notice however full and formal as to the existence of a prior deed can take the place of registration.”⁹⁸

The potential litigation outcome that causes concern about the recording laws is exemplified in *Barber v. Brunson*.⁹⁹ In *Barber*, a deed of trust’s registration was held to be void because, the court said, it was “registered on a defective probate.”¹⁰⁰ The deed of trust was to have been executed by three individuals. The notary’s certificate was in a form for spouses and was left with blank lines for their names and for identification of the county in which the notary was commissioned and in which the acknowledgment was taken.¹⁰¹ The court held the recording to be invalid without explaining the significance of the omitted information, or whose rights may have been affected by this defect in form. Without this background, *Barber* is hard to reconcile with cases such as *Banks v. Shaw*,¹⁰² in which the court refused to invalidate a deed of trust that had an acknowledgment form for only a wife when the instrument was signed by a husband and wife. In that case the court stated: “It appears that the deed of trust was properly executed and acknowledged. Hence the omission in the notary’s certificate was a matter of proof. The certificate could be amended subsequently to speak the truth, no rights of creditors or third parties being invoked.”¹⁰³ Notwithstanding this logical explanation, the outcome of *Barber* causes concern as to whether an instrument will be denied the effects of registration because it contains a format irregularity.

There are reasons to believe that *Barber* was an anomaly. A consistent theme in other cases in which an instrument’s registration was invalidated are issues with the instrument’s legitimacy—not simply with the form of acknowledgment or probate. For example, *Allen v. Burch*¹⁰⁴ involved a statute that enabled the plaintiff to record a deed executed by a deceased person based on an affidavit that the “affiant believes such deed to be a bona fide deed and executed by the grantor

97. See, e.g., *id.* at 259-73 (discussing inquiry notice).

98. *McClure v. Crow*, 146 S.E. 713, 714 (N.C. 1929).

99. *Barber v. Brunson*, 161 S.E. 549 (N.C. 1931).

100. *Id.* at 550.

101. *Id.* at 549.

102. *Banks v. Shaw*, 41 S.E.2d 281 (N.C. 1947).

103. *Id.* at 281.

104. *Allen v. Burch*, 55 S.E. 354 (N.C. 1906).

therein named.”¹⁰⁵ The affidavit merely stated that the grantor and witnesses were dead and that the affiant could not give proof of the handwriting. Justice Connor, writing for the court, said the required attestation of the deed’s legitimacy was “the substance of the affidavit” and its absence could not be overlooked.¹⁰⁶

In a number of cases, the court held that deeds acknowledged or probated before unauthorized officials were not entitled to protection under the recording laws. In each, the instrument’s legitimacy was suspect. The circumstances have involved, for example, a deed probated by the grantee’s heir and relative,¹⁰⁷ a conveyance for a corporation executed by an individual for whom there was no evidence of corporate authority,¹⁰⁸ acknowledgment by a notarial officer who was a preferred creditor of the signatory,¹⁰⁹ and a clerk who probated his own certificate.¹¹⁰

A careful examination of the reported cases should dispel a conviction that a court will invalidate an instrument’s registration merely because it contains a mistake in the form of a probate or acknowledgment. The North Carolina Supreme Court once quoted the following from a legal encyclopedia: “‘courts uniformly give to certificates of acknowledgement a liberal construction, in order to sustain them if the substance be found, and the statute has been substantially observed and followed. It is accordingly a rule of universal application that a literal compliance with the statute is not to be required of a certificate of acknowledgement, and that, if it substantially conforms to the statutory provisions as to the material facts to be embodied therein, it is sufficient.’”¹¹¹ The cases show that the courts’ real concern has been with instruments whose legitimacy is in doubt—not with errors in the form of certificates describing the events. As the North Carolina Supreme Court once asked, “Are the instruments to be adjudged void merely because probates are deficient in matters of form and not of substance?” The court then answered that the proper concern was about substance.¹¹²

105. *Id.* at 355 (quoting Acts 1905, ch. 277, sec. 1981, 1905 Public Laws 323).

106. *Id.*

107. *Scranton and N.C. Land & Lumber Co. v. Jennett*, 37 S.E. 954 (N.C. 1901).

108. *Bernhardt v. Brown*, 29 S.E. 884 (N.C. 1898).

109. *Long v. Crews*, 18 S.E. 499 (N.C. 1893).

110. *White v. Connelly*, 11 S.E. 177 (N.C. 1890); *see also* *Norman v. Ausbon*, 138 S.E. 162 (N.C. 1927) (clerk could not probate instrument to which he was a party); *Woodlief v. Woodlief*, 135 S.E. 612 (N.C. 1926) (recorded deed that was not probated was not admissible as evidence); *Buchanan v. Hedden*, 85 S.E. 417 (N.C. 1915) (invalidating deed that was signed by a power of attorney that was not probated and that lacked a proper signature).

111. *Freeman v. Morrison*, 199 S.E. 12, 14 (N.C. 1938) (quoting 1 C.J. Acknowledgment, Sec. 183, p. 841).

112. *Bailey v. Hassell*, 115 S.E. 166, 169 (N.C. 1922)

The courts' inclination to look beyond inconsequential matters of form was made early on in *Quinnerly v. Quinnerly*,¹¹³ in which the court refused to invalidate a mortgage just because an adjudication of the acknowledgment was not in proper form. The court distinguished between a situation in which "the probate was in fact insufficient," in which case "the registration was invalid and of no effect," and a shortcoming in the manner in which the probate was depicted on the instrument.¹¹⁴ The court stated "[t]he presumption is that it was properly taken," and "[a]s the validity of the registration may be thus impeached, so it may be supported by the same kind of evidence."¹¹⁵ In a number of other cases the North Carolina Supreme Court similarly has looked beyond form to the substance of the alleged impropriety.¹¹⁶

The courts have also refused to allow a challenge to registration based on alleged errors in formality not obvious on the face of the instrument unless the party claiming the benefit of the defective acknowledgment was aware of the disqualifying circumstance.¹¹⁷ For example, an acknowledgment by a South Carolina notary was taken in North Carolina, where the notary had no authority, but the instrument indicated that the acknowledgment occurred in South Carolina. The court would not invalidate the instrument's registration unless the party challenging it could prove that the grantee was aware of the defect.¹¹⁸ This rule makes sense; those who rely on recorded instruments should have no obligation to investigate beyond the records to

113. 19 S.E. 99 (N.C. 1894).

114. *Id.* at 99.

115. *Id.*

116. See *Consolidated Realty Corp. v. Henderson*, 197 S.E. 144 (N.C. 1938) (obvious transcription mistake in notarial certificate that indicated notary was from West Virginia rather than North Carolina held not to invalidate the instrument); *Roberts v. Saunders*, 134 S.E. 451, 453 (N.C. 1926) ("[T]he mere fact that no seal appeared upon the records in the office of the register of deeds is not conclusive as to whether or not a seal was actually affixed to said deed"); *County Sav. Bank v. Tolbert*, 133 S.E. 558 (N.C. 1926) (finding certificate said it was completed in South Carolina when it was actually in North Carolina; the court held the error was not patent and therefore did not invalidate the registration); *Mfirs. Fin. Co. v. Amazon Cotton Mills Co.*, 109 S.E. 67 (N.C. 1921) (holding that an instrument which was "subscribed and sworn to before" a notary public was equivalent to its being acknowledged); *Smith v. Ayden Lumber Co.*, 56 S.E. 555 (N.C. 1907) (holding omission of signatures by register's transcription did not invalidate registration); *Hatcher v. Hatcher*, 37 S.E. 207 (N.C. 1900) (holding proper execution and acknowledgment of a grantor's signature, in the absence of any acknowledgment on the instrument, could be proved by testimony of the justice of the peace who performed the acknowledgment); *Matter of Hess*, 407 S.E.2d 594, 595 (N.C. Ct. App. 1991) (rejecting a contention that an instrument was defective because its acknowledgment did not state that the affiant personally and voluntarily acknowledged making it; the court said: "There is no requirement that the acknowledgement itself contain any magical language to show that it was executed personally and voluntarily by the affiant.").

117. *Blanton v. Bostic*, 35 S.E. 1035 (N.C. 1900).

118. *Id.* at 1036.

determine whether something went awry in the instrument's preparation for recording. But allowing challenges to proceed if the error is obvious invites opportunism. Someone who notices an invalidating defect could acquire a competing interest expecting to be given priority because the already recorded instrument will be denied registration status. Such an unacceptable outcome could be avoided only if the courts look beyond the recording statute and employ a constructive trust or other equitable theory. This potential is yet another example of how adherence to an oversimplified rule can have an untoward result.

C. *Statutory Rationality*

Although continued emphasis on public records as the source of title information has merit, especially as the records and their use become more accessible, continuation of a rule in which a conveyance can be subordinated based on a technical recording defect undercuts the system's intended reliability. The recording laws are intended to remove obstacles to marketability, not introduce new ones.

The possibility of technical invalidity unduly diverts attention away from the substance of the transaction toward immaterial details. The notary seal requirements enacted into law in 2005 are an excellent example. On the day the law took effect, most notary seals in use contained such things as small circles or dots that are prohibited under a strict interpretation of the new requirements to the effect that they allow only prescribed components on the seal image. Registers, who must verify the presence of an "official seal" on deeds and deeds of trust before accepting them for recording, were unsure about whether they could accept instruments if they had such seals. A potential debacle was averted when the North Carolina Department of the Secretary of State, which regulates notaries, issued an e-mail stating that the new seal requirements did not apply to seals obtained by notaries before the legislation's effective date.¹¹⁹ Important real estate conveyances and finance were momentarily put in doubt by an unintended effect of notary regulations.

The potential for recording invalidation based on technical flaws is a remnant of a regime in which form was allowed to prevail over substance. In 1853, for example, the North Carolina Supreme Court rejected an attorney's argument that a recorded deed could not be ignored because it "was spread upon the record, and for all useful purposes had the same notoriety as if duly acknowledged or proven,

119. E-mail from Gayle Holder, Director Notary Public Section, North Carolina Department of the Secretary of State, to NCARD Mailing List (December 1, 2005, 12:21 EST) (on file with author).

so that the objection is technical.”¹²⁰ The court was not persuaded, holding that “where a thing is not done in due form, it is not done at all in contemplation of the law.”¹²¹ Since then, the courts wisely have not been so formalistic.

As discussed above,¹²² realistically courts are unlikely to invalidate registration based on “technical or unsubstantial objections,” but instruments remain subject to challenge due to the manner in which the courts have sometimes described the statutes and the absence of any legislative clarification. The possibility of invalidation due to a defect in form is a serious impediment to the reliability that the race recording law was intended to achieve. Over the years the General Assembly has addressed technical objections only in piecemeal fashion. The North Carolina statutes contain a number of curative provisions that validate instruments with certain kinds of defects or that were prepared during defined periods, many of which address the kinds of discrepancies that have been held by the courts not to invalidate instruments.¹²³ For example, the statutes validate instruments missing a register’s certificate before October 1, 2004,¹²⁴ and validate acknowledgments missing seals, names, and signatures prior to January 1, 1991.¹²⁵ The General Assembly’s inclination to waive defects when asked raises doubt about justification for leaving other instruments with the same kinds of defects subject to challenge merely from lack of similar attention. Technical noncompliance cannot be very important if the legislature so willingly forgives it.

In *Weston v. J.L. Roper Lumber Co.*,¹²⁶ the North Carolina Supreme Court noted the illogic of a rule that would invalidate a registration “where no substantial departure from legal requirements appeared, but merely an irregularity which could be cured without injury to the rights of others.”¹²⁷ The court also quoted from a United States Supreme Court opinion that observed that some courts, “by unnecessary strictness in their construction of the statutes, added to the insecurity of titles, in a country where too many have acted on the supposition that every one who can write is fit for a conveyancer. The great evils likely to arise from a strict construction applied to the bona fide conveyances of an age so careless of form have compelled Legislatures to quiet titles by confirmatory acts, in order to prevent the

120. *DeCourcy v. Barr*, 45 N.C. 181, 185 (1853).

121. *Id.*

122. *See supra* text accompanying notes 111-16.

123. N.C. GEN. STAT. §§ 47-47 to -108.26 (2005).

124. *Id.* § 47-50.1.

125. *Id.* § 47-53, -54.

126. 75 S.E. 800 (1912).

127. *Id.* at 801.

most gross injustice.’”¹²⁸ The concerns to which the Court referred persist as shown by the continued appearance of curative acts.

Almost forty years ago, Professor James A. Webster, Jr.,¹²⁹ a leading authority on North Carolina real estate law, argued for more sweeping legislation to cure technical defects in acknowledgments. He observed that “[a] rule that dictates that a perfectly executed, perfectly recorded instrument is incapable of giving either constructive or actual notice under the recordation statutes, or which bars the admissibility of such instrument as evidence in a lawsuit, has little to commend it.”¹³⁰ He noted that “at the present time many defects of record caused by faulty acknowledgments, probates, and recordations are simply clogging the marketability of land.”¹³¹ To cure acknowledgment defects, he proposed a statutory provision declaring that duly signed and recorded instruments are “valid and effective in law as if each instrument has been correctly acknowledged” “notwithstanding the instruments have not been acknowledged before an officer authorised by the laws of North Carolina to take acknowledgments or which have not been otherwise properly acknowledged, or the acknowledgments of which have not been taken and certified in conformity with the laws of this State in force at the time each such instrument was executed.”¹³² Professor’s Webster’s conclusions remain valid and his recommendation still deserves consideration.

Some other states’ laws overcome technical invalidity in different ways, all of which are viable alternatives for North Carolina. For example, an Arkansas statute lists a number of irregularities that will not affect an instrument’s recording status, including specified missing or incorrect acknowledgment certificate components.¹³³ Virginia limits the time in which a document’s legitimacy can be challenged, declaring that all recorded instruments “shall be conclusively presumed to be in proper form for recording after having been recorded for a period of three years, except in cases of fraud.”¹³⁴ This gives affected parties a limited time to challenge an instrument. Still, the fairness of subjecting instruments to challenge on matters of form, even for a limited time, is questionable in a modern transactional environment.

A more comprehensive approach to avoiding some of the potential irrational results from application of the recording laws would be to

128. *Id.* at 802 (quoting *Webb v. Den*, 58 U.S. 576, 577 (1854)).

129. Professor Webster was the original author of North Carolina’s treatise on real estate law, *Webster’s Real Estate Law in North Carolina*, *supra* note 57.

130. James A. Webster, Jr., *Toward Greater Marketability of Land Titles—Remedying the Defective Acknowledgment Syndrome*, 46 N.C.L. REV. 56, 70 (1967).

131. *Id.* at 68.

132. *Id.* at 69-70.

133. ARK. CODE ANN. § 18-12-208 (2003).

134. VA. CODE ANN. § 55-106.2 (Michie 2003).

redefine the kind of notice for which a purchaser or creditor will be held accountable. North Carolina could join the many other states that have adopted a race-notice recording statute, the form of which is described above.¹³⁵ The choice would be the same as it was in 1885: whether to emphasize registration with the hope of making the records more reliable, or to emphasize protecting good faith purchasers and creditors against those with actual notice of competing claims. The answer may be different today than it was in 1885. A statute that expressly acknowledges that purchasers and creditors will not be allowed to ignore actual notice of another's claim would be a more accurate depiction of the law than the statute currently provides, given the numerous exceptions to the registration requirement and the courts' willingness to consider actual notice when the equities demand.

Other states have chosen a race-notice statute based on similar experiences with race statutes.¹³⁶ It is also the type of statute endorsed in the Uniform Simplification of Land Transfers Act, the only modern significant effort to unify state laws governing real estate instrument recording.¹³⁷ The uniform law was not adopted by any state and was withdrawn by the National Conference on Uniform State Laws that had drafted it. It was not withdrawn because of any substantive objections to the proposed recording rule approach, but for a number of other reasons, including, according to some, opposition by real estate attorneys to change, especially if it would diminish reliance on their services.¹³⁸ Such concerns should not impede legislation that would result in more coherent laws for those who depend on them.

A more limited approach would be for North Carolina to modify the race recording statutes only to address the knowledge deemed to be given by recording. The race recording laws are silent about notice. They say only, in relevant part, that no conveyance is "valid to pass any property interest as against lien creditors or purchasers for a valuable consideration but from the time of registration thereof in the county where the land lies."¹³⁹ The courts early on construed the statute to deny any notice effect to an instrument deemed not to be prop-

135. *See supra* text accompanying note 4.

136. Powell, *supra* note 8, § 82.02[1][c][i].

137. Uniform Simplification of Land Transfers Act §§ 3-201 to -205 (1976).

138. Ronald Benton Brown, *Whatever Happened to the Uniform Land Transactions Act?*, 20 NOVA L. REV. 1017 (1996).

139. N.C. GEN. STAT. §§ 47-18(a), -20, -27 (2005) (respectively applying to: conveyances, contracts, options, and leases; deeds of trust and other security interests; and easements). The statutes also provide that to be validly registered a deed of trust or mortgage of real property or a lease must be registered "in each county where any portion of the land lies in order to be effective as to the land in that county." *Id.* §§ 47-20.1, -20.4. The notice issue discussed above would not relieve a secured creditor from this obligation nor should it.

erly registered,¹⁴⁰ an interpretation that the General Assembly could address with legislation that reflects decades of experience with the statute and the changes that have taken place in the transactional environment.

Some states address the notice question by specifically defining the notice effect of recording. For example, Illinois has a statute that provides that instruments “shall be deemed, from the time of being filed for record, notice to subsequent purchasers and creditors, though not acknowledged or proven according to law; but the same shall not be read as evidence, unless their execution be proved in a manner required by the rules of evidence applicable to such writings, so as to supply the defects of such acknowledgement or proof.”¹⁴¹ Although the statute appropriately acknowledges the notice that recorded defective instruments impart, the blanket declaration that any recorded instrument gives notice to all cannot be given its plain meaning. Constructive or record notice is based on the assumption that someone should be able to find the instruments that apply to particular real estate. By necessity a search of the records must focus on conveyances to and from an owner during ownership; examiners cannot reasonably be expected to search for every possible conveyance or encumbrance recorded at any time involving every owner in the chain of title.¹⁴² For example, a searcher cannot fairly be held accountable for failing to find an easement deed given by someone owning multiple parcels over time if the easement was not recorded until decades after the owner who gave the deed conveyed the subject property away. The courts and commentators have recognized that “nothing is notice unless reasonable inquiry must lead from it to the fact, apparent to a reasonable purchaser, that there exists a hostile title earlier and presumably superior to that which his vendor offers.”¹⁴³ The North Carolina Supreme Court has acknowledged the need for this qualification, holding that an instrument binds a purchaser only “if enough is disclosed by the index to put a careful and prudent examiner upon inquiry, and if upon such inquiry the instrument would be found.”¹⁴⁴ Any statutory declaration that recording constitutes notice and binds subsequent purchasers and creditors therefore should be

140. *See supra* text accompanying notes 94-102.

141. 765 ILL. COMP. STAT. 5/31 (2001). For examples of similar ways to describe the notice given by recording, *see, e.g.*, KANS. STAT. ANN. § 58-2222 (1994); OHIO REV. CODE ANN. § 5301.01(B)(1)(b) (Anderson 2004).

142. Francis S. Philbrick, *Limits of Record Search and Therefore of Notice, Part III*, 93 U. PA. L. REV. 391, 415 (1944) (“Search is only made against each name, from the day before the date of the deed into him, to the day after the record of the deed out of him.”).

143. *Id.* at 396 (emphasis omitted).

144. *Dorman v. Goodman*, 196 S.E. 352, 355 (N.C. 1938).

limited to apply only to instruments that a reasonable searcher would find.¹⁴⁵

Another approach to being explicit about notice of a recorded instrument would be to amend the statute to provide as follows, which borrows some of Professor Webster's suggested curative language but takes the next step:

Any party acquiring or conveying an interest in real property shall be deemed to have record knowledge of any instrument on record at the time of acquisition at the register of deeds in the county in which any portion of such real property is situated, if reasonable inquiry would lead to discovery of such instrument. Such record knowledge shall be deemed to have been acquired notwithstanding that the registration of any instrument, or form of acknowledgment or proof appearing thereon, did not comply with the laws of this state for the registration of real property instruments. Record knowledge shall be the same as constructive knowledge as is deemed given by valid registration.

This would equate recording with constructive notice notwithstanding problems of form that have no bearing on the instruments' legitimacy or the equities of those affected. The result would be a recording law that continues to require recording but that deems notice to have been given by an instrument's appearance in the chain of title in the public record.

IV. THE FRAUDULENT OR FRIVOLOUS LIEN PROBLEM

For decades, the records were protected by subjecting presented instruments to an official review before they could be recorded. That kind of review became impossible in the modern transactional and financing environment, as the volume and rapidity of real estate conveyances and financing dramatically increased, and legal instruments took on more complex forms, often generated in others states or countries. The modern environment demands that instruments be more readily recordable.

The increased availability of information in modern society presents an opportunity for those who wish to harm others through fraud, false claims, and annoyance. The threat to the real estate records is a serious part of this development, because the potential impact of a fraudulent or frivolous real estate filing can interfere with a transaction involving substantial investments, or impair someone's capacity to obtain credit. For example, some wrongdoers file instruments that claim a "nonconsensual lien" against a targeted public official, which is de-

145. Wisconsin law addresses the chain of title issue by declaring that purchasers are not bound by an instrument outside the chain of title unless a conveyance within the chain refers to the instrument. Chain of title is then defined to include matters discoverable by a reasonable search of the records and indexes. WIS. STAT. ANN. §§ 706.09(1)(b), 706.09(4) (West 2001).

picted as a claim to the official's property unless the public official responded within a limited time. Although the frivolous nature of these instruments is readily apparent, the instruments can nonetheless cause harm to the target by holding up a transaction or impairing credit while the instrument is investigated.

Since 2001, a North Carolina statute directs superior court clerks not to accept claims of a lien on real property unless the claim is authorized by statute.¹⁴⁶ The statute provides that an attempt to file such a document is considered a misdemeanor offense.¹⁴⁷ The statute applies only to superior court records. The statutes do not require or authorize registers to refuse to accept instruments even if they seem intended for no purpose other than to harass. Registers cannot reasonably be put in the position of having to scrutinize the validity of complex instruments prepared by sophisticated legal counsel. Registers are elected officials with heavy responsibilities and limited resources. The risk of loss to the parties from erroneous rejection of an instrument, and the potential liability of the registers, are too great to warrant putting registers in that gate-keeping role.

Those harmed by abuse of the recording system must therefore look to civil or criminal laws for remedies. Current law is inadequate and provides little deterrence against abuse. North Carolina recognizes a cause of action for slander of title. Recovery for slander of title requires proof of false statements about the title to property, malice, and damages.¹⁴⁸ Such actions are rare in North Carolina.¹⁴⁹ The cause of action typically is raised in connection with challenges to the merits of litigation of which notice has been given.¹⁵⁰ Proving the elements for slander of title, especially malice, is difficult.¹⁵¹

Some states recently have enacted legislation to address the problem of frivolous or false liens or claims against real estate. Wyoming law has the most comprehensive statute. It addresses a number of the ramifications of frivolous filings by authorizing a damages award, attorneys' fees reimbursement, injunctive relief for a groundless or false lien or claim, and by providing for an expedited hearing process. The

146. N.C. GEN. STAT. § 44A-12.1(a) (2005).

147. *See id.* § 44A-12.1(b).

148. *Allen v. Duvall*, 304 S.E.2d 789, 791 (N.C. Ct. App. 1983).

149. *Id.*

150. *See id.* (finding only three cases in which slander of title was addressed prior to 1989: *Texas Co. v. Holton*, 27 S.E.2d 293 (N.C. 1943) (holding comments about lease insufficient to sustain cause of action); *Cardon v. McConnell*, 27 S.E. 109 (N.C. 1897) (cause of action rejected because statement was truthful); *McElwee v. Blackwell*, 94 N.C. 261 (1886) (recognizing cause of action exists for statements about trademark)).

151. For cases noting the proof of malice requirement, *see Chatham Estates v. American Nat'l Bank*, 88 S.E. 783 (N.C. 1916); *Quinn v. Quinn*, 433 S.E.2d 807 (N.C. Ct. App. 1993); *Allen v. Duvall*, 304 S.E.2d 789 (N.C. Ct. App. 1983).

hearing provides a mechanism to invalidate any claim of lien against government officials and employee based on their duties. The law also makes use of such liens a criminal misdemeanor.¹⁵² Other states consider it a felony to file a forged, groundless, or false claim intentionally;¹⁵³ provide for a damages remedy and award of attorneys' fees for filing a frivolous or false lien or claim;¹⁵⁴ authorize multiple damages;¹⁵⁵ or provide for different remedies based on whether the defendant caused the instrument to be recorded or was merely named in it.¹⁵⁶ Some statutes simply declare claims of nonconsensual common law liens to be invalid.¹⁵⁷

The currently available common law remedies offer little protection against the potential harm that can be caused by fraudulent or frivolous claims filed in the public records. The time and money it takes to remove a wrongful lien cannot realistically be recovered adequately with available common law remedies. An expedited hearing process, enhanced damages, and criminal sanctions are all sensible tools for preserving the system's integrity and for discouraging its abuse.

V. CONCLUSION

In 1885, North Carolina's legislative leaders said they wanted recording laws that made real estate more marketable by making the public records a reliable single source of information about titles. Since then, transactional realities and legislative initiative have disproved the notion that the public record alone determines rights to real estate. Lawmakers are justifiably cautious about changing well-established legal rules on which important rights depend. If North Carolina's race recording statute as applied were as pure as it was envisioned, changing it could unsettle expectations and affect perceived vested rights. However, the reality is different from the textual simplicity. The North Carolina Supreme Court once said it would focus its review of real estate instruments "so that the essence of what was done should not be sacrificed to the form of doing it."¹⁵⁸ The state's recording statutes are due for re-examination to ensure that they coherently and clearly focus on this essence.

152. WYO. STAT. ANN. § 29-1-311 (2005). The summary review process allows the court *ex parte* to order a hearing to occur as soon as fifteen days after a petition is filed by someone challenging a lien, and the court may declare the lien invalid, and award damages, if the person claiming the lien fails to appear. *See id.* § 29-1-311(b).

153. KY. REV. STAT. ANN. § 434.155 (1999).

154. COLO. REV. STAT. § 38-35-109(3) (2004); IDAHO CODE § 45-1705 (Michie 2003).

155. ARIZ. REV. STAT. § 33-420 (2000); UTAH CODE ANN. § 38-9-4 (2005).

156. ARIZ. REV. STAT. § 33-420 (2000); N.M. STAT. ANN. § 48-1A-9 (Michie Supp. 2003).

157. N.M. STAT. ANN. § 48-1A-5 (Michie Supp. 2003).

158. *Weston v. J.L. Lumber Co.*, 75 S.E. 800, 801 (N.C. 1912).

ADDENDUM O

The eRecording of Maps and Plats: History and Background of the Legal and Professional Opinions with References to Enabling Legislation

Following the eRecording of three (3) maps through a pilot project in Johnston County, NC, surveyors and county registers of deeds expressed concerns about the legality of the submission and receipt of electronically recorded maps. Specifically, do state and federal legislative acts such as the Uniform Electronic Transactions Act, the Uniform Real Property Electronic Recording Act, and eSign satisfy the requirements set forth in G.S. §47-30, “Plats and subdivisions; mapping requirements”? The concerns included the following:

- If a surveyor is testifying in court and is asked if a plat completed and filed electronically for recordation by him complies with the certification statement in G.S. §47-30 and shown on the referenced plat, could he truthfully answer “Yes”?
- Should Registers of Deeds verify and reject maps in digital formats that don’t meet (or are not capable of being reproduced) in traditional (18 x 24, 24 x 36, 21 x 30, etc.) file sizes as set forth in G.S. 47-30?
- Should Registers of Deeds reject original maps that are not “ink on Mylar” as set forth by G.S. 47-30?
- Are Registers of Deeds authorized to accept maps in digital formats submitted for electronic recordation?

Upon obtaining an Attorney General’s Opinion and other legal and professional opinions supporting the legal ability for electronic maps to be recorded, there were still some concerns, not so much about the legality of submitting and recording electronic maps/plats, but about assuaging the fears of some who were still not convinced and needed clarification in writing as to the full statutory support codified in Chapter 66, Article 40 (UETA), and G.S. §47-16 (URPERA). The North Carolina Association of Registers of Deeds is seeking legislative measures to that end.

The Electronic Recording Council established a sub-committee to examine these concerns and to report to the full NCERC their findings and recommendations. The sub-committee agreed to recommend to the NCERC to include documentation in the standards of the congruency of Chapter 66, Article 40 (UETA), and G.S. §47 -16 (URPERA) with §G.S. 47-30. Registers of Deeds may rely on federal and state statutes including, but not limited to UETA and URPERA, and consult the legal and professional opinions contained within these standards in Addendum O. Specific changes to the Standards recommended by the sub-committee and NCERC included the following:

- 1) The addition of Standard 11 – **eRecordation of Maps and Plats.**

10/20/11

- 2) Amendment of Standard 1 to include a specific acknowledgment of maps and plats, and the addition of the following language: “Electronic recording vendors need to provide a method to verify the size of each instrument presented to the Register of Deeds electronically.”
- 3) Amend the sample Memorandum of Understanding in Addendum K to accommodate the submission and receipt of electronically recorded maps and plats.
- 4) Include the legal and professional opinions in a new Addendum O.

The referenced legal and professional opinions are contained in the next few pages.

- 1) N.C. Attorney General’s Opinion dated 4-13-10**
- 2) 7/28/09 legal opinion from Professor Pat Hetrick, Land Records Advisory Council Chair**
- 3) N. C. Society of Surveyors professional opinion dated 5-7-10**



STATE OF NORTH CAROLINA
DEPARTMENT OF JUSTICE

ROY COOPER
ATTORNEY GENERAL

REPLY TO:
Elizabeth N. Strickland
Transportation Section

April 13, 2010

Representative Mitch Gillespie
North Carolina General Assembly
House of Representatives
16 West Jones Street, Room 1008
Raleigh, North Carolina 27601-1096

Dear Representative Gillespie,

I have been asked to respond to your recent inquiry "If a Surveyor testifying in court is asked if a plat completed and filed electronically for recordation by him complies with the certification statement in N.C. Gen. Stat. § 47-30 and shown on the referenced plat, could he truthfully answer 'Yes.'" The certification statement in G. S. § 47-30 (d) provides:

Certificate; Form – There shall appear on each plat a certificate by the person under whose supervision the survey or plat was made, stating the origin of the information shown on the plat, including recorded deed and plat references shown thereon. The ratio of precision before any adjustments must be shown. Any lines on the plat that were not actually surveyed must be clearly indicated and a statement included revealing the source of information. Where a plat consists of more than one sheet, only one sheet must contain the certification and all other sheets must be signed and sealed.

The certificate required above shall include the source of information for the survey and date indicating the ratio of precision of the survey before adjustments and shall be in substantially the following form:

"I, _____, certify that this plat was drawn under my supervision from an actual survey made under my supervision (deed description recorded in Book _____, page _____, etc.) (other); that the boundaries not surveyed are clearly indicated as drawn from information found in Book _____, page _____; that the ratio of precision as calculated is 1: _____; that this plat was prepared in accordance with G.S. 47-30 as amended. Witness my original signature, registration number and seal this _____ Day of _____, A.D., _____.

Seal or Stamp

Surveyor
Registration Number

MAILING ADDRESS:
DEPARTMENT OF TRANSPORTATION
ATTORNEY GENERAL'S OFFICE
1505 MAIL SERVICE CENTER
RALEIGH, NC 27699-1505

TELEPHONE: 919-733-3316
FACSIMILE: 919-733-9329

LOCATION:
TRANSPORTATION BUILDING
1 SOUTH WILMINGTON STREET
RALEIGH, NC 27601

Representative Mitch Gillespie

April 13, 2010

Page 2

Based on a review of applicable laws, the answer is yes, so long as it meets the minimum requirements of the Secretary of State's rules for registration and absent any irregularities in the preparation or registration of the plat. Plats registered electronically are reproducible at the Register of Deeds, or, in some counties, directly from the Register of Deeds web site.

G.S. § 47-16.4. Recording of documents provides: (b) A register of deeds: . . . (2) may receive, index, store, archive, and transmit electronic documents.

G.S. § 47-16.3. Validity of electronic documents provides: (a) If a law requires, as a condition for recording, that a document be an original, be on paper or other tangible medium, or be in writing, **the requirement is satisfied by an electronic document** satisfying this Article [the Uniform Real Property Electronic Recording Act or "URPERA"]. (Emphasis added.) URPERA gives legal equivalency to electronically filed or registered documents. This statute also provides: (c) A requirement that a document or a signature associated with a document be notarized, acknowledged, verified, witnessed, or made under oath is satisfied if the electronic signature of the person authorized to notarize, acknowledge, verify, witness, or administer the oath, and all other information required to be included, is attached to or logically associated with the document or signature. A physical or electronic image of a stamp, impression, or seal need not accompany an electronic signature. Nothing in this act shall prohibit the North Carolina Board of Examiners for Engineers and Surveyors from requiring that the image of a seal accompany any plat or map that is presented electronically for recording.

The North Carolina Board of Examiners for Engineers and Surveyors does require a seal or a facsimile of a seal to be on final drawings or plans prepared by a surveyor:

G.S. 89C-16(c) Each licensee shall upon licensure obtain a seal of a design authorized by the Board bearing the licensee's name, license number, and the legend, "professional engineer," or "professional land surveyor." **Final drawings, specifications, plans and reports prepared by a licensee shall, when issued, be certified and stamped with the seal or facsimile of the seal** unless the licensee is exempt under the provisions of G.S. 89C-25(7). It shall be unlawful for a licensee to affix, or permit the licensee's seal and signature or facsimile of the seal and signature to be affixed to any drawings, specifications, plans or reports after the expiration of a certificate or for the purpose of aiding or abetting any other person to evade or attempt to evade any provision of this Chapter. A professional engineer practicing land surveying shall use the licensee's land surveyor seal.

(Emphasis added.)

The Rules enacted by the North Carolina Board of Examiners for Engineers and Surveyors, codified in Section 1103 of Chapter 56 of Title 21 of the North Carolina Administrative Code, provides for the electronic transmission of such documents:

(d) Electronically Transmitted Documents. Documents, including drawings, specifications and reports, that are transmitted electronically beyond the direct control of the licensee shall have the computer-generated seal removed from the original file, unless signed with a digital signature as defined in Paragraph (e) of this Rule. After removal of the seal the electronic media shall have the following inserted in lieu of the signature and date: "This document originally issued and sealed by (name of sealer), (license number), on (Date of sealing). This medium shall not be considered a certified document." Hardcopy documents containing the original seal, signature and date of the licensee may be duplicated by photocopy or electronic scanning processes and distributed either in hardcopy or electronic medium. The scanned digital files of certified documents are not subject to the requirements of this Paragraph. The electronic transmission beyond the direct control of the licensee of CAD, vector or other files subject to easy editing are subject to the requirements of this paragraph. Easy editing is based on the file consisting of separate elements that can be individually modified or deleted. Documents that are excepted from certification by a statement meeting the requirements of Subparagraphs (c)(1) through (c)(5) of this Rule are not subject to the requirements of this Paragraph.

(e) Documents to be electronically transmitted beyond the direct control of the licensee that are signed using a digital signature, shall contain the authentication procedure in a secure mode and a list of the hardware, software and parameters used to prepare the document(s). Secure mode means that the authentication procedure has protective measures to prevent alteration or overriding of the authentication procedure. The term "digital signature" shall be an electronic authentication process that is attached to or logically associated with an electronic document. The digital signature shall be:

- (1) Unique to the licensee using it;
- (2) Capable of verification;
- (3) Under the sole control of the licensee; and
- (4) Linked to a document in such a manner that the digital signature is invalidated if any data in the document is changed.

Further statutory support of electronic authentication is in the Uniform Electronic Transactions Act, codified in Chapter 66, Article 40, of the General Statutes:

§ 66-317. Legal recognition of electronic records, electronic signatures, and electronic contracts:

(c) If a law requires a record to be in writing, an electronic record satisfies the law provided it complies with the provisions of this Article.

Based on the foregoing authorities, a Register of Deeds is authorized to accept a plat sent electronically. A Surveyor is authorized to submit a plat for registration electronically. A Surveyor could truthfully respond "Yes" that a plat prepared by him and filed electronically at a Register of Deeds complies with G.S. 47-30.

I hope that this satisfactorily answers your inquiry. If you have any questions or I can provide further information, please do not hesitate to contact me.

Any opinions stated in this correspondence have not been approved in accordance with the procedures for an official Attorney General's Opinion.

Sincerely,

A handwritten signature in black ink, appearing to read "Elizabeth N. Strickland", with a long horizontal flourish extending to the right.

Elizabeth N. Strickland
Special Deputy Attorney General



North Carolina General Assembly
House of Representatives

REPRESENTATIVE MITCH GILLESPIE
85TH DISTRICT
OFFICE TELEPHONE: (919) 733-5862
(919) 754-3167 FAX
EMAIL: mitchg@ncleg.net
HOME ADDRESS: 185 CROSS CREEK NORTH RIDGE DRIVE
MARION, NC 28752

COMMITTEES:
APPROPRIATIONS SUBCOMMITTEE ON
TRANSPORTATION
COMMERCE, SMALL BUSINESS AND
ENTREPRENEURSHIP
ENVIRONMENT AND NATURAL RESOURCES,
VICE CHAIR
FEDERAL RELATIONS AND INDIAN AFFAIRS
WATER RESOURCES AND INFRASTRUCTURE
WAYS AND MEANS / BROADBAND
CONNECTIVITY

March 25, 2010

MEMORANDUM

TO: Attorney General
FROM: Rep. Mitch Gillespie
SUBJECT: Request for Attorney General Opinion
REQUESTED BY: Rep. Mitch Gillespie
QUESTION:

If a Surveyor testifying in court is asked if a plat completed and filed electronically for recordation by him complies with the certification statement in G.S. 47-30 and shown on the referenced plat, could he truthfully answer "Yes."?

APPLICABLE STATUTES,
RULES, REGULATIONS,
MANUALS OR POLICIES:

G.S. 47-30 Plats and Subdivisions; mapping requirements
G.S. 47.16.3 Validity of Electronic Documents
Uniform Real Property Electronic Recording Act (URPERA)

FACTUAL SITUATION
GIVING RISE TO THE
NEED FOR AN OPINION:

As electronic recordation of documents has become more acceptable in the marketplace, an increasing number of document types have been electronically recorded in North Carolina within the last few years. To this end, a movement is currently underway to electronically record survey plats/maps.

In 2009 using the Uniform Real Property Electronic Recording Act, G.S. 47-30 and G.S. 47-16.3 as a base along with an increase in consumer desire for electronic real estate transactions statewide, the North Carolina Land Records Advisory Committee began reviewing processes in place for the electronic recordation of survey plats. Upon review and after receiving insight from relevant stakeholders, the North Carolina Secretary of State's Office along with register of deeds, planning department and local surveyors in Johnston County, NC recently completed a successful pilot project in electronically recording survey documents in the county's registry of deeds.

Feedback has been received since the completion of the project specifically from the North Carolina Electronic Recordation Council that surveyors may not have the legal right to present maps in electronic format for recordation. This viewpoint is based upon G.S. 47-30(b) which requires plats to be presented in hard copy format for recordation and therefore a surveyor may perjure himself when completing the required certification to all aspects of G.S. 47-30 if the plat in fact will be electronically recorded.

Please see the attachment of the Memorandum from the Land Records Advisory Committee and the attachment dealing with the primary question. If you have further questions please contact Sara Kusan, Executive Director, NC Society of Surveyors, 919-556-9848, skusan@ncsurveyors.com or Rep. Mitch Gillespie, 828-442-6953 (cell), mitchg@ncleg.net. This request is time sensitive and an opinion in two weeks would be appreciated.

A handwritten signature in black ink that reads "Mitch Gillespie". The signature is written in a cursive, flowing style.

LAND RECORDS ADVISORY COMMITTEE

Memorandum

To: Members of the Land Records Advisory Committee

From: Pat Hetrick, Professor of Law, Campbell University School of Law
Chair, N. C. Land Records Advisory Council

Re: Effect of URPERA, N.C.Gen.Stat. § 47-16.3, on Requirements of
N.C.Gen.Stat. § 47-30(b)

Date: July 28, 2009

The issue is whether an “electronic document” as defined in the Uniform Real Property Electronic Recording Act (URPERA), Article 1A of Chapter 47 of the North Carolina General Statutes, satisfies the requirements set forth in subsection (b) of N.C.Gen.Stat. § 47-30, “Plats and subdivisions; mapping requirements.” The answer is yes.

N.C.Gen.Stat. § 47-30(b), a typical state statute that pre-dates URPERA, reads as follows:

(b) Plats to Be Reproducible.--Each plat presented for recording shall be a reproducible plat, either original ink on polyester film (mylar), or a reproduced drawing, transparent and archival (as defined by the American National Standards Institute), and submitted in this form. The recorded plat must be such that the public may obtain legible copies. A direct or photographic copy of each recorded plat shall be placed in the plat book or plat file maintained for that purpose and properly indexed for use. In those counties in which the register has made a security copy of the plat from which legible copies can be made, the original may be returned to the person indicated on the plat. (*Emphasis added.*)

A fundamental reason why the National Conference of Commissioners on Uniform State Laws drafted the Uniform Real Property Electronic Recording Act, URPERA, was to eliminate a remaining challenge to the recordation of electronic documents after the passage of UETA and E-SIGN: state laws that prohibited or called into question the validity of accepting electronic documents for recording.

Since UETA and E-SIGN applied only to “transactions,” it was unclear whether the act of recording constituted a “transaction.” Hence, URPERA was a necessary addition to the uniform laws. N.C.Gen.Stat. § 47-30(b) is an example of the type of pre-existing recording act statute that the drafters of URPERA sought to supercede insofar as the acceptability of electronic documents for recordation is concerned.

URPERA, at N.C.Gen.Stat. § 47-16.2(1), defines “document” as follows:

- (1) “Document” means information that is:
 - a. Inscribed on a tangible medium or that is stored in an electronic or other medium and is retrievable in perceivable form; and
 - b. Eligible to be recorded in the land records maintained by the register of deeds.

A “tangible medium” in plain English is a means for storing information that is comprehensible or understandable by users of that medium.

URPERA, at N.C.Gen.Stat. § 47-16.2(3), defines “electronic document” as “a document that is received by the register of deeds in an electronic form.”

URPERA, at subsection (a) of N.C.Gen.Stat. § 47-16.3, “Validity of electronic documents,” reads:

- (a) If a law requires, as a condition of recording, that a document be an original, be on paper *or other tangible medium*, or be in writing, the requirement is satisfied by an electronic document satisfying this Article. (*Emphasis added.*)

The reference in G.S. 47-30(b) to “a reproducible plat, either original ink on polyester film (mylar), or a reproduced drawing, transparent and archival (as defined by the American National Standards Institute)” is a requirement, “as a condition of recording, that a document be an original, be on paper or other tangible medium, or be in writing.” Therefore, the requirement of N.C.Gen.Stat. § 47-30(b) is satisfied by application of URPERA, N.C.Gen.Stat. § 47-16.3, assuming that any other requirements of URPERA are satisfied.



North Carolina Society of Surveyors, Inc.

May 7, 2010

State of North Carolina
Department of the Secretary of State
P.O. Box 29626
Raleigh, NC 27626-0626

Attn: Wayne Rash
Electronic Recording Council Chair

RE: URPERA and G.S. 47-30

Dear Mr. Rash:

The North Carolina Society of Surveyors (NCSS) Board of Directors met on Saturday, May 1, 2010 for its quarterly meeting in Wake Forest, NC. All Executive Officers (President, Past President, President Elect, Vice President, Secretary-Treasurer and NSPS Delegate) and all 19 local Chapter Presidents were present for the meeting. There were also a number of regular NCSS members in attendance as well as Tom Morgan, NC Land Records Manager.

A portion of this meeting was spent dealing with the apparent differing opinions of the Uniform Real Property Electronic Recording Act (URPERA) with regard to North Carolina General Statute 47-30 (G.S. 47-30) between North Carolina's Land Records Advisory Committee (LRAC) and the Electronic Recording Council (ERC). All NCSS board members were briefed on all aspects of the issue at hand and given copies of the following documents for review;

- Frank Mundy's (NCSS LRAC Appointee) Liaison report dated April 20, 2010
- Doug Suttles' (NCSS ERC Appointee) Liaison report dated April 2010
- Land Records Advisory Committee Meeting Minutes for meeting dated October 21, 2008
- Land Records Advisory Committee Meeting Minutes for meeting dated May 7, 2009
- Article by Frank Mundy on this subject in June 2009 Edition of the Tarheel Surveyor
- Land Records Advisory Committee Meeting Minutes for meeting dated July 28, 2009
- Memorandum to LRAC from Pat Hetrick, LRAC Chair dated July 29, 2009
- Land Records Advisory Committee Meeting Minutes for meeting dated November 17, 2009
- Press Release from World Wide Notary on eSigning and eRecordation of Maps and Plats dated February 11, 2010
- Letter to Frank Mundy from Secretary of State Elaine Marshall dated February 24, 2010

- Article by James Rhodes on this subject in March 2010 edition of the NC Planning Association Newsletter
- Electronic Recording Council Meeting Minutes for meeting dated March 9, 2010
- Email from Ozie Stallworth, SOS office, to ERC Members dated March 10, 2010 on GS 47-16.3
- Handout from Tom Morgan given to NCSS Triangle Chapter dated March 16, 2010
- Letter from NC Attorney General's Office to Representative Mitch Gillespie dated April 13, 2010
- Press Release from NC Department of Transportation highlighting eRecordation in Johnston County dated April 15, 2010
- Email from David Tuttle, Board Counsel for the NC Board of Engineers of Engineers and Land Surveyors, to Frank Mundy dated April 21, 2010 entitled, "G.S. 47-30".

NCSS Board members were guided through each page of the documents mentioned above. In addition, a recap of Tom Morgan's previous statements from a few years was given on the potential requirement of legislation revisions to G.S. 47-30. These statements occurred while he was the NCSS representative to the ERC. As mentioned, Mr. Morgan, now NC Land Records Manager, was in attendance and briefed all attendees on his current viewpoint on the issue at hand.

After all of this information was reviewed the following motion was made from the floor and passed 24-1 (President does not vote). The position adopted by the NCSS Board of Directors is as follows;

"The North Carolina Society of Surveyors' official position is that URPERA satisfies G.S. 47-30 with regard to map and plat materials and signatures."

Please note that the lone dissenting vote was not opposed to URPERA where G.S. 47-30 is concerned but took the stance that electronic media is not "archival" and the only "archival" medium is mylar (polyester film).

The North Carolina Society of Surveyors looks forward to continuing our successful relationship with the Secretary of State's office be it through dealings with office staff or with associated committees and councils such as the LRAC and ERC. We also are excited to see the pilot program grow from its foundation in Johnston County to other geographic locations in the state. Together with our local chapters, NCSS is willing, able and ready to do our part to make electronic recording of plats and maps in North Carolina an immediate reality.

Should you require any additional information please feel free to contact Sara Kusan, NCSS Executive Director, or myself directly.

Sincerely,

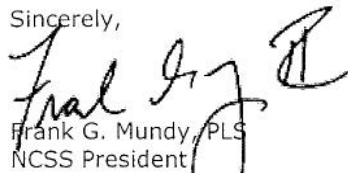

Frank G. Mundy, PLS
NCSS President

cc: Pat Hetrick, LRAC Chair
Patty Holloway, NC SOS Office (for distribution)

331 South White Street * P.O. Box 2101 * Wake Forest, NC 27588
919-556-9848 * Fax: 919-556-9888 * Website: ncsurveyors.com